

Farquhar Park Aquatic Center

York, PA



Technical Report #3

Jason Kukorlo

Structural Option

Consultant: Dr. Linda M. Hanagan

December 1, 2009

TABLE OF CONTENTS

I.	Executive Summary.....	3
II.	Introduction.....	4
III.	Structural System Overview	
	Foundation.....	7
	Superstructure.....	8
	Lateral System.....	11
IV.	Codes and Design Standards.....	23
V.	Building Load Summary	
	Gravity Loads.....	25
	Lateral Loads.....	27
VI.	SAP Models.....	35
VII.	Stiffness Values.....	36
VIII.	Load Combinations	37
IX.	Center of Mass	38
X.	Center of Rigidity	39
XI.	Shear	41
XII.	Drift and Displacement	51
XIII.	Overturning	55
XIV.	Spot Checks	56
XV.	Conclusion	61
XVI.	Appendices – Hand Calculations	
	Appendix A – Center of Mass.....	62
	Appendix B – Direct Loads.....	81
	Appendix C – Torsional Loads.....	86

Executive Summary

The Lateral System Analysis and Confirmation Design discusses the existing lateral system of the Farquhar Park Aquatic Center natatorium. Wind and seismic loads calculated for Technical Report 1 were revised and applied to the lateral force resisting system consisting of steel braced frames, steel moment frames, and concrete shear walls. The original calculated wind loads did not account for the fact that internal pressures cancel each other out. Therefore, the revised wind loads used for this assignment were lower than those calculated in Technical Report 1. In addition, the story levels for this Lateral System Analysis were different than those used originally for Technical Report 1, thus changing the wind and seismic loads applied to the building. Loads were applied to the frames using the appropriate load combinations from ASCE 7-05.

Two-dimensional models of the lateral force resisting frames were created using SAP2000 and used to determine frame displacements and member internal forces and moments. A 1-kip load was applied to each frame at each level and compared to the displacement at that level to determine the stiffness of each frame at each level. The center of mass and center of rigidity at each level were calculated by hand, along with the direct loads and torsional loads applied to each frame. Drift and story drift values were determined at each level and compared to allowable code values for wind and seismic loads. Overturning moments and impacts on foundations were also considered and discussed, and spot checks of critical members were performed.

In order to properly distribute the applied wind and seismic loads to the frames that actually resist those loads, the entire building was divided into four separate “buildings”. For instance, the main concrete floor system and grandstand seating area only cover a small area compared to the entire plan area of the building. Therefore, the seismic loads caused by the floor and grandstand seating will not get transferred to the lateral force resisting frames at the other end of the building across the indoor pool. Wind and seismic loads were carefully applied only to the frames that were actually taking those forces. Overall, almost all drift and story drift values were within the allowable limits set forth by ASCE 7-05. Spot checks performed on a column of a moment frame and on diagonal braces of two braced frames confirmed that these members were adequately designed for strength. In addition, overturning moments were determined to have a minimal impact on foundations and are therefore not much of a concern.

Introduction

The Farquhar Park Aquatic Center is a 37,000 square foot multi-level, state-of-the-art natatorium complex designed by Nutec Design Associates, Inc., a full-service architectural and engineering firm located in York, PA. The facility is located in the city of York and features a 53-foot high natatorium with raised seating, a 12-foot deep indoor swimming pool with diving platforms, a 3,600 square foot single story masonry bath house, and a large outdoor swimming pool, as can be seen in Figure 1. The complex was intended to be used by the YMCA of York, but the original design was never constructed due to cost and budget concerns. The natatorium contains an entry level, a concourse level, and a gallery level. The main entrance opens up into an expansive 24-foot high lobby that spans from one end of the building to the other. The lobby provides access to concessions, men's and women's toilets, and corridors that connect the main lobby to the indoor swimming pool area. The entry level also contains men's and women's lockers and showers, a team room, offices, storage rooms, timer room, utility room, dish room, and trophy display case.



Figure 1 – Aerial View of Natatorium Complex

Concrete stairs near the main entrance lead up to the concourse level which houses a mechanical room and a team store. A long precast concrete ramp also connects the ground floor to the second floor. The floor of the concourse level sits about 10 ½' above the ground level and consists of 12" precast hollow core concrete planks, as can be seen in Figure 2. Visitors can overlook the lobby below behind a 3 ½' guardrail. A precast L-shaped concrete balcony spans the entire length of the pool and provides access to the grandstand seating area.

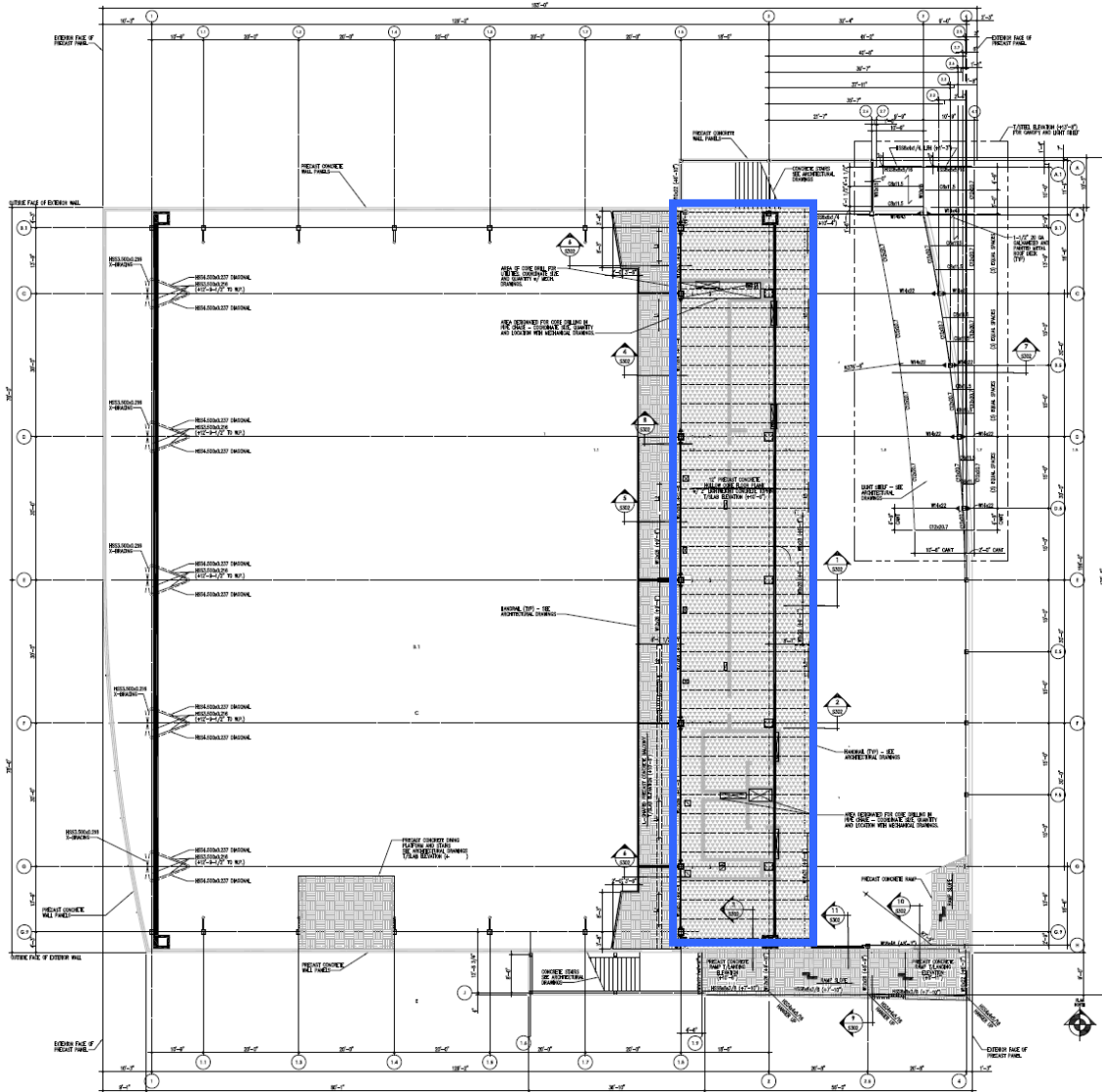

Figure 2 - Concourse Level Framing Plan (12" precast concrete hollow core floor planks are shown in blue – they span 27'-0" and run almost the entire length of the building)

The natatorium's curved roof spans about 130'0" and is supported by large trusses, creating a very open space. The lower roof above the lobby sits about 14' below the lowest point of the curved roof and contains most of the mechanical units. Trusses spaced at 15'-0" on-center support the roof and units. The east-facing and west-facing exterior walls of the natatorium are both slightly curved. At each end of the indoor swimming pool area is a large, curved glazed aluminum curtain wall made of Solera-T glazing. These two curtain walls are each 123'-11" long, 21'-0" tall at their highest points, and 8'-0" tall at their shortest points. Precast concrete panels are primarily used as the façade along with a mix of metal wall panels and glazed curtain walls, as can be seen in Figure 3.

Nutec Design Associates designed the facility to comply with certain LEED credits for the project to achieve LEED Silver Certification. Thermal shading effects were provided by a façade plant climbing system that helped to reduce indoor air temperatures. Another sustainability feature was the natural daylighting provided by the large glass curtain walls enclosing the indoor swimming pool area. Other requirements were related to certain materials and ensuring that they are environmentally friendly.



Figure 3 – View of Main Entrance of Natatorium (showing precast concrete panels, metal wall panels, and glazed curtain walls)

Structural System Overview

Foundation

The geotechnical evaluation was performed by GTS Technologies, Inc. on September 30, 2005. The study included five boring tests, only one of which hit water and revealed a water level 12'-0" below existing site grades. The recommended allowable bearing pressure from GTS Technologies for compacted structural fill was 2500 psi. A shallow foundation system consisting of isolated spread footings at various depths was used. Most of the foundations were located about 2'-0" below finished floor elevation, however a few along the west side of the natatorium were located about 15'-0" below finished floor elevation in order to get below the pool structure. This can be seen in Figure 4. Footings range in size from 4'-6"x4'-6"x1'-0" up to 19'-0"x19'-0"x2'-0". Larger foundations were required to handle the loads carried by the trusses spanning across the indoor pool.

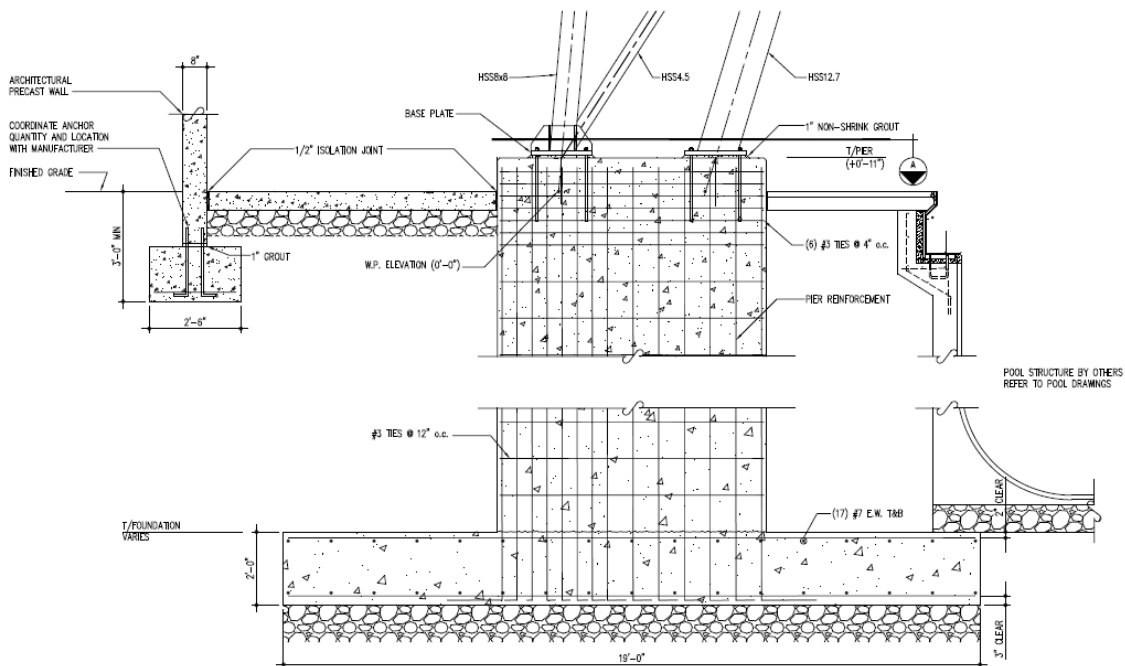

Figure 4 – Detail of Pier Supporting Large Tapered Truss Column

Concrete with a compressive strength of 4,000 psi was used for the footings. Reinforcement in the footings consists of #5, #6, and #7 bars, while reinforcement in the piers consists of #6 and #8 bars, with the #8 bars only being used in the large, deep piers supporting the tapered truss columns. A typical pier detail is shown in Figure 5. Strip footings were 2'-6" wide for interior walls and 2'-0" wide for exterior walls. Geotechnical reports indicate that exterior footings shall be embedded a minimum of 36 inches below final grade for frost protection. Foundations were to be placed on a geotextile layer to minimize the loss of aggregate materials into the subgrade. Due to the

proximity of Willis Creek Run and the fact that water was found in one boring test, the geotechnical report suggests that the bottom layer of the pool slab be designed to include a 12-inch No. 57 aggregate drainage layer and pressure release valves to prevent potential floatation due to ground water when the pool is drained.

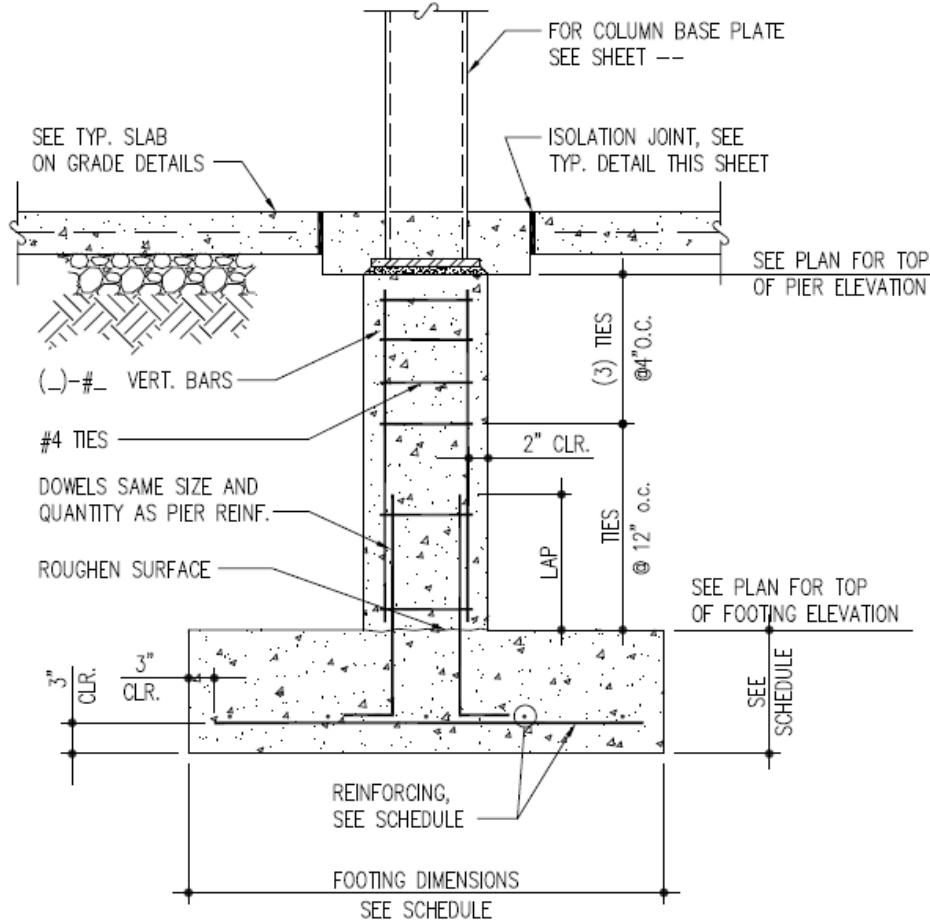

Figure 5 – Typical Pier Detail

Superstructure

The ground floor consists of a 4" concrete slab-on-grade with 6x6 W2.0xW2.0 W.W.F. on 4" crushed stone base and a compressive strength of 4,000 psi. The concession area sits on a recessed concrete slab, and a portion of the floor slab near the pool structure becomes 8" thick with #4 bars at 12" on-center L.W. and #5 bars at 12" on-center S.W. HSS columns in the lobby run along the east wall and support the roof trusses above the lobby. The entry level also contains 12" CMU walls with #5 bars at 32" on-center that are grouted solid full height. These walls enclose parts of the bathrooms, locker rooms, offices, team room, storage rooms, and utility room and are located beneath the grandstand seating area. A floor plan of the entry level is shown in Figure 6. Precast

concrete columns help support the 8" precast concrete ramp that runs from the ground floor up to the concourse level. The ramp is also supported by W-shape beams, HSS columns, and hangers.

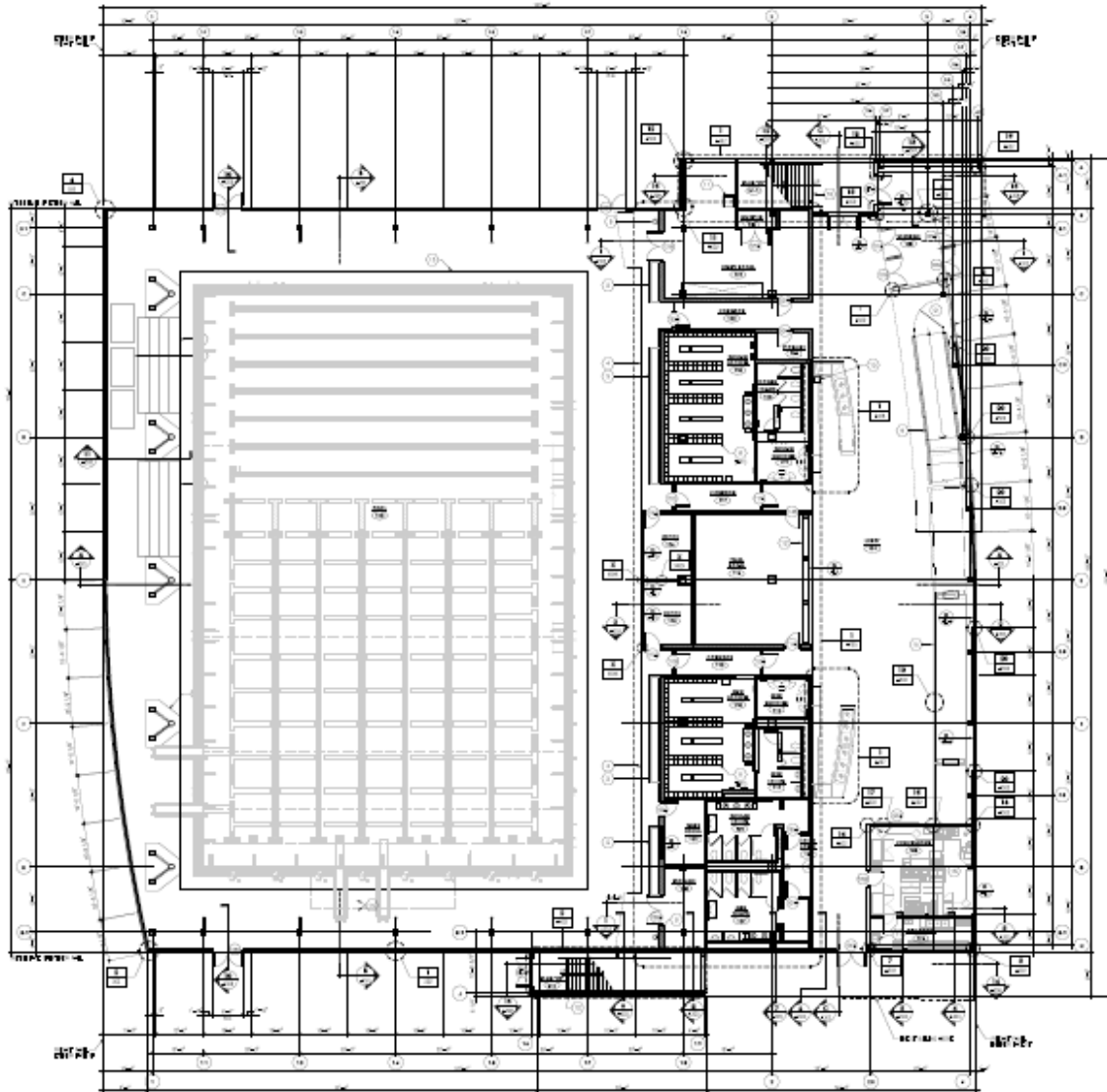

Figure 6 – Entry Level Floor Plan

Triangular HSS trusses spanning 130'-0" support the large curved roof above the indoor swimming pool area and are shown in Figure 7. The columns for these trusses are triangular, tapered, and spaced 30'-0" on center. Both the trusses and the supporting columns are made up of HSS members. Long span deck was used to span between the trusses. The other ends of the large trusses are supported by HSS18x18x5/8 columns. HSS wind column trusses run along the north and south walls in the indoor pool area as well. The trusses are 3'-0" deep and vary in height with the tallest at 51'-2 1/4" above finished floor elevation. The wind column trusses connect into the main roof diaphragm. The rest of the high roof framing primarily consists of HSS6x6 and HSS8x8 members.



Figure 7 – Rendering of Indoor Pool Area Showing Large Curved Trusses

The precast concrete grandstand seating area that runs from the concourse level to the gallery level is supported by sloped W27x94 beams that frame into the HSS18x18x5/8 members that also support the large curved trusses. The floor system of the concourse level consists of 12” precast concrete hollow core floor planks with 2” lightweight concrete topping, as is shown in Figure 8. Top of slab elevation is 10’-6”. The precast concrete balcony is supported by a 12” CMU wall, and additional strength is provided by a 12” beam with two continuous #5 bars. A canopy and light shelf near the main entrance and lobby are slightly higher than the concourse level and are supported by cantilevered W14x22 and W14x43 beams. Additional framing is provided by C8x11.5 beams and curved C12x20.7 beams. Moment connections allow the W14 beams to cantilever from the supporting HSS10x10 columns.

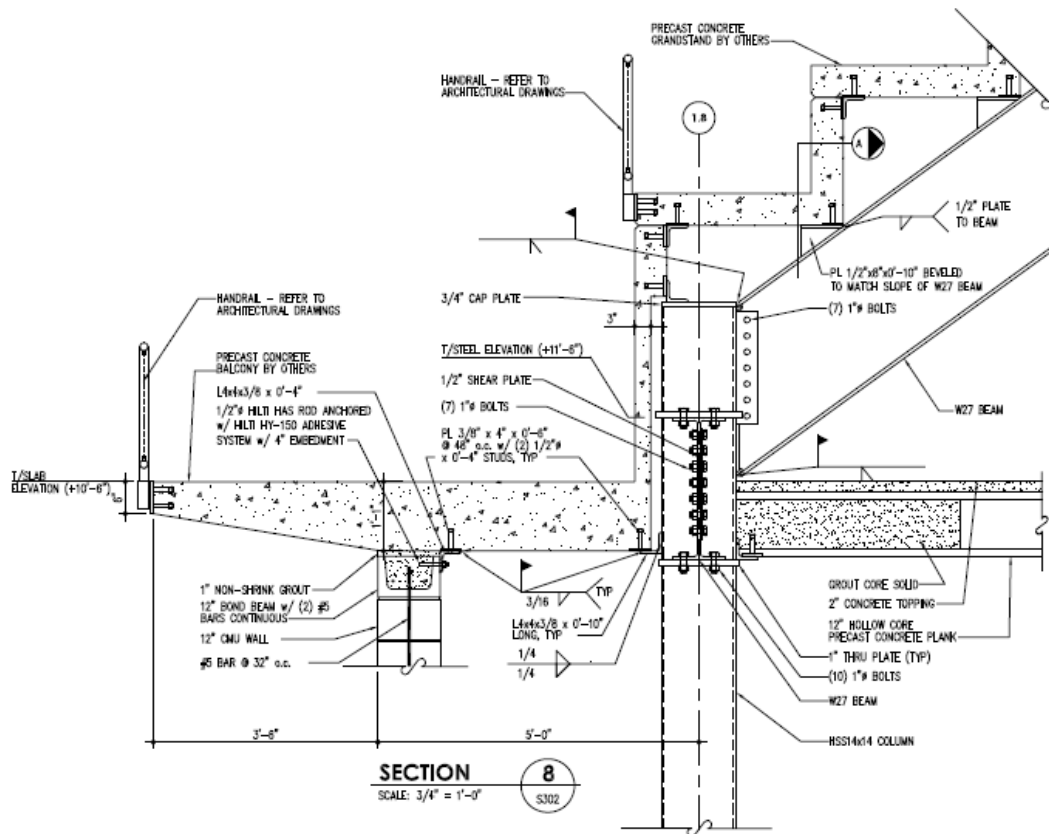

Figure 8 – Section Showing the 12” Hollow Core Precast Concrete Planks, the Precast Concrete Balcony, and the W27x94 Beams Supporting the Concrete Grandstand

The gallery level has HSS roof trusses spanning about 41'-0" and spaced 15'-0" (and 2'-5" deep) supporting 6" 18 GA acoustical long span metal roof deck with 18 GA perforated cover and polyencapsulated acoustical batt insulation. The trusses are 2'-5" deep, slightly sloped, and also support the mechanical unit support framing above. The top of steel elevation for the mechanical unit support framing is 28'-0", and the framing consists of W8, W10, and C8 beams.

Lateral System

The large truss columns and mezzanine moment frame take the lateral load in one direction, while the truss columns, a frame between the pool and lobby, and frame at the front of the lobby handle the lateral load in the other direction. Some lateral load from the mezzanine goes into the CMU walls, but the steel moment frame provides most of the lateral support. The wind columns are designed to simply take the wind force and transfer it to the roof diaphragm. A mezzanine level framing plan is shown in Figure 9, and a roof framing plan is shown in Figure 10. The wind columns transfer roughly half the load to the ground or base connection and the other half of the load to the high roof diaphragm. The roof diaphragm transfers the load to the large trusses over the indoor

pool, which in turn sends part of the load to the five large braced truss columns and the rest of the load to the mezzanine moment frame system. The large truss columns are laterally braced by HSS3.500x0.216 X-bracing. The two chords of the truss columns are offset by four feet at the base, providing a rather rigid support that can handle high lateral loads. The large trusses and supporting truss columns can be seen in Figure 11, and the wind columns can be seen in Figure 12.

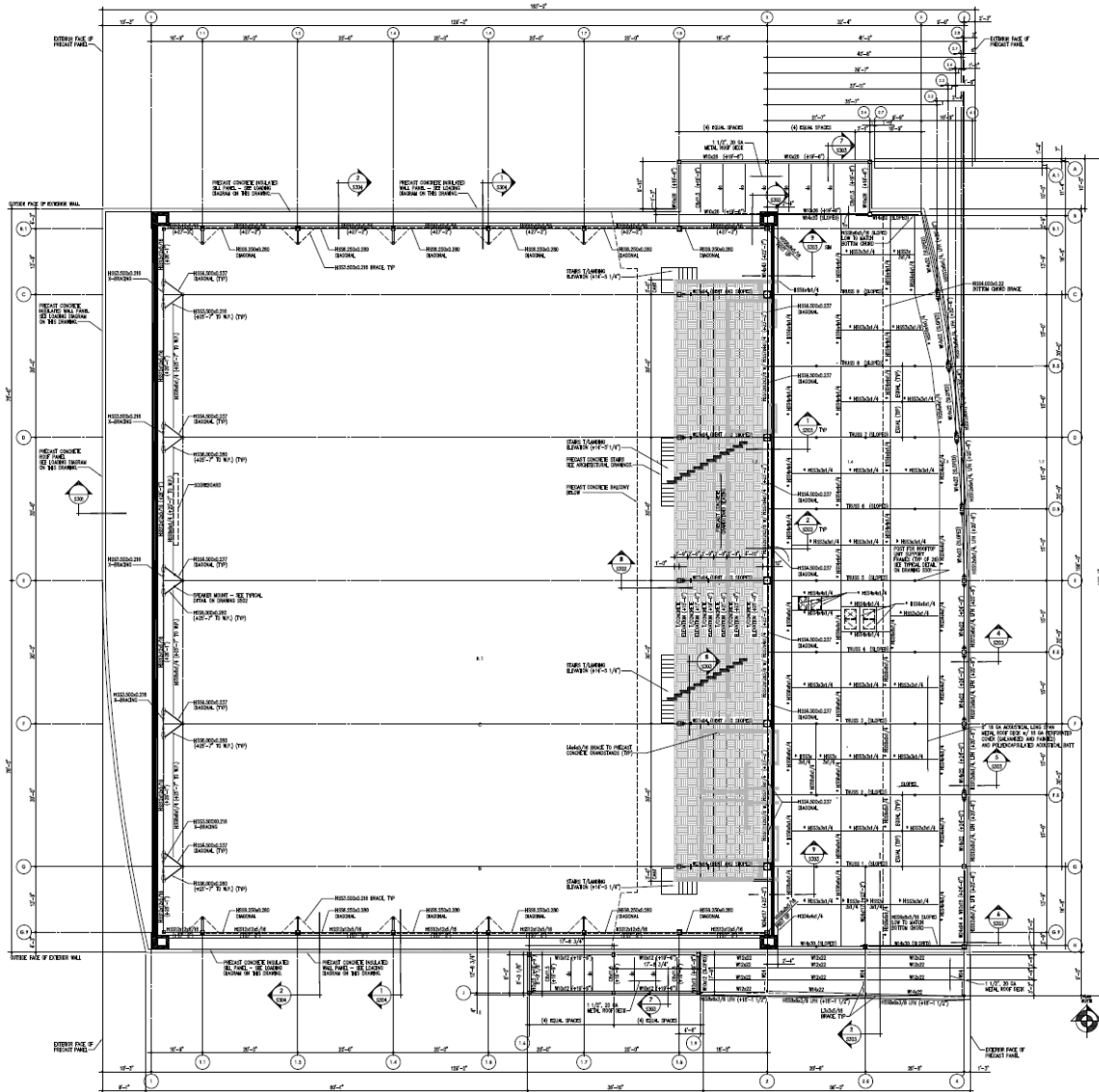

Figure 9 – Gallery/Mezzanine Level Framing Plan (the shaded portion is the grandstand seating area)

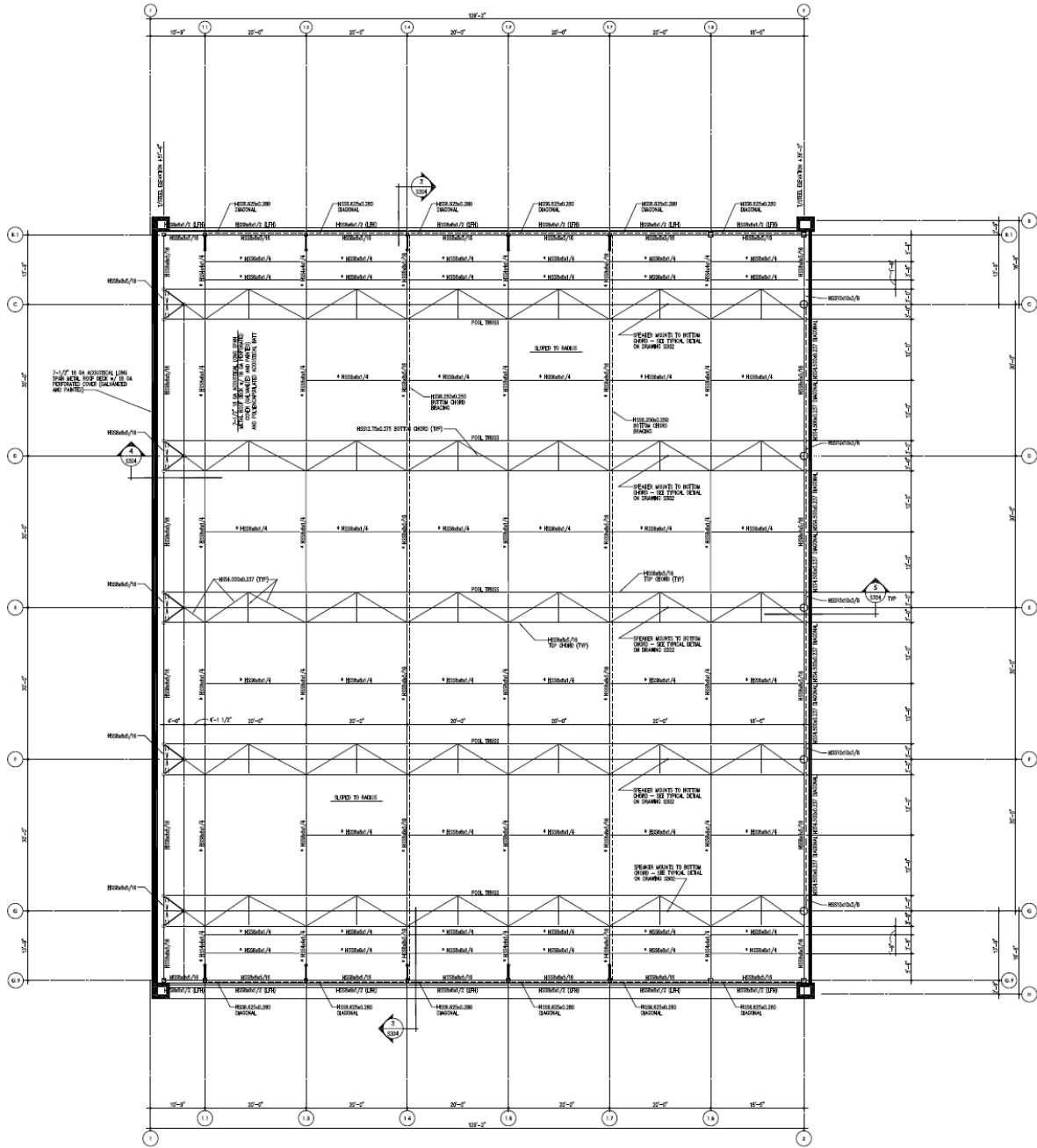

Figure 10 – Roof Framing Plan (including the five large trusses above the pool area and additional framing)

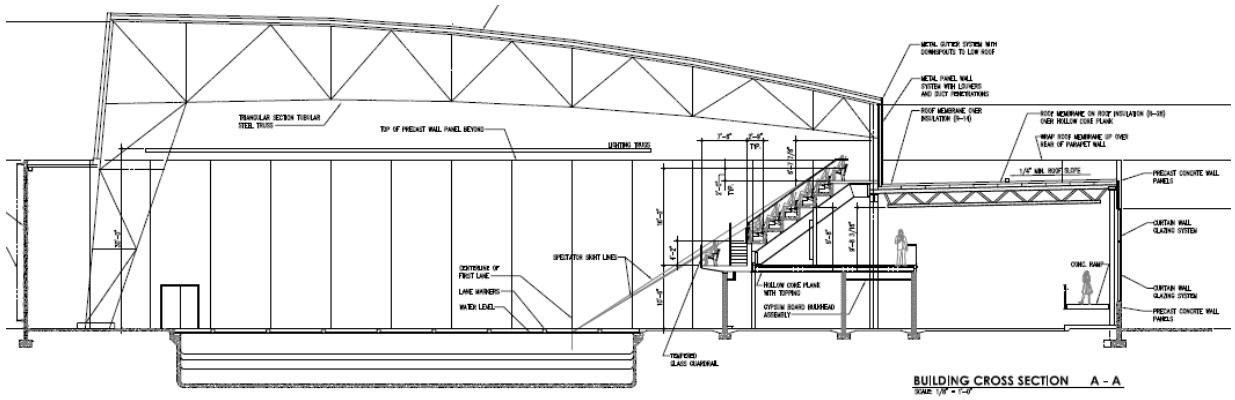

Figure 11 – Cross Section Through Center of Building

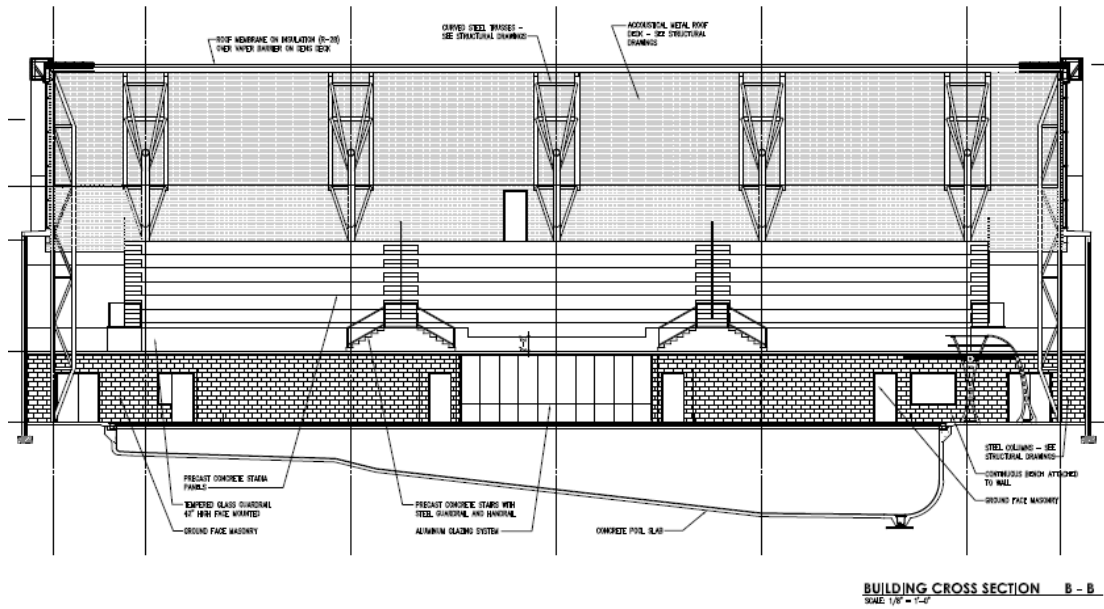

Figure 12 –Cross Section Through Indoor Pool Area Showing the Wind Columns

For lateral load analysis in the North/South direction, the entire building was basically broken up into four separate “buildings” in order to properly distribute the wind and seismic forces to the frames or walls that are actually resisting them. For instance, the truss columns supporting the large trusses that span over the indoor pool will see little or none of the seismic load caused by the precast hollow core floor planks that are located towards the right half of the building (see Figure 11). There is no load path for this seismic force to get the whole way over to the left truss columns at column line 1.

The whole building was divided into 4 levels that very closely line up with the levels of the lateral forces resisting elements and the levels of the floor slabs:

Level	Elevation
4	53'-0"
3	37'-8"
2	24'-8"
1	10'-6"

Table 1 – Elevation of each level used in lateral analysis

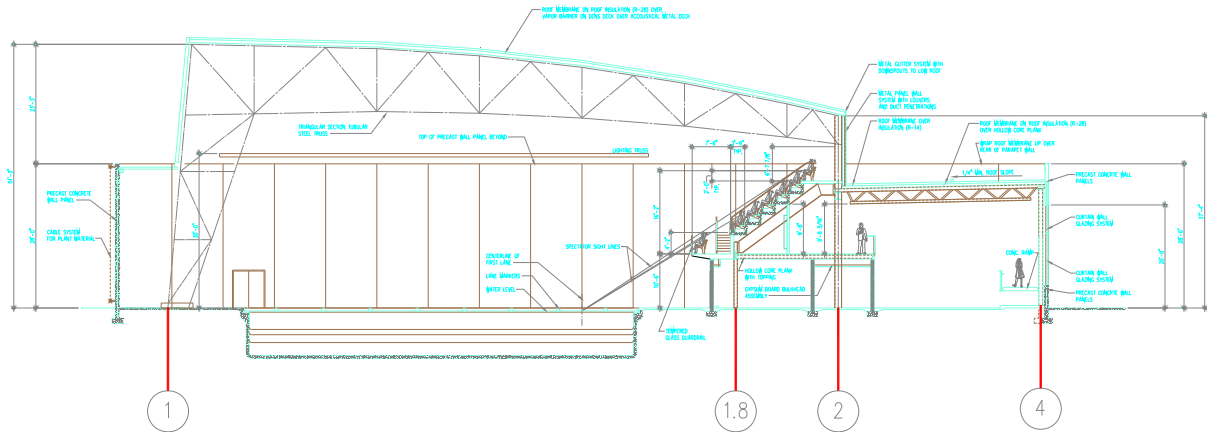

Figure 13 – Cross Section of Building looking in the North/South direction showing columns lines where lateral force resisting frames are located

“Building 1” consists of the area enclosing the indoor pool area, which includes a braced frame at column line 1 (the large truss columns) and a braced frame at column line 2. Elevations of these frames are shown below in Figures 13 and 14. There are five identical braced frames along column line 1 each spaced 30’-0” apart. For this analysis, only one of the braced frames at column line 1 was modeled since all five frames are the same, and each frame takes 1/5 of the load applied at column line 1. The additional framing at the high roof level connects all of the trusses together and basically creates a rigid diaphragm. Hence, it was assumed that each truss frame deflected the same amount and took the same load. A 2D model of each frame was used for the lateral force resisting analysis in this report. Seismic loads (mainly from the roof and exterior concrete panels) and wind loads applied to “Building 1” are transferred to the braced frames at column line 1 and the braced frame at column line 2.

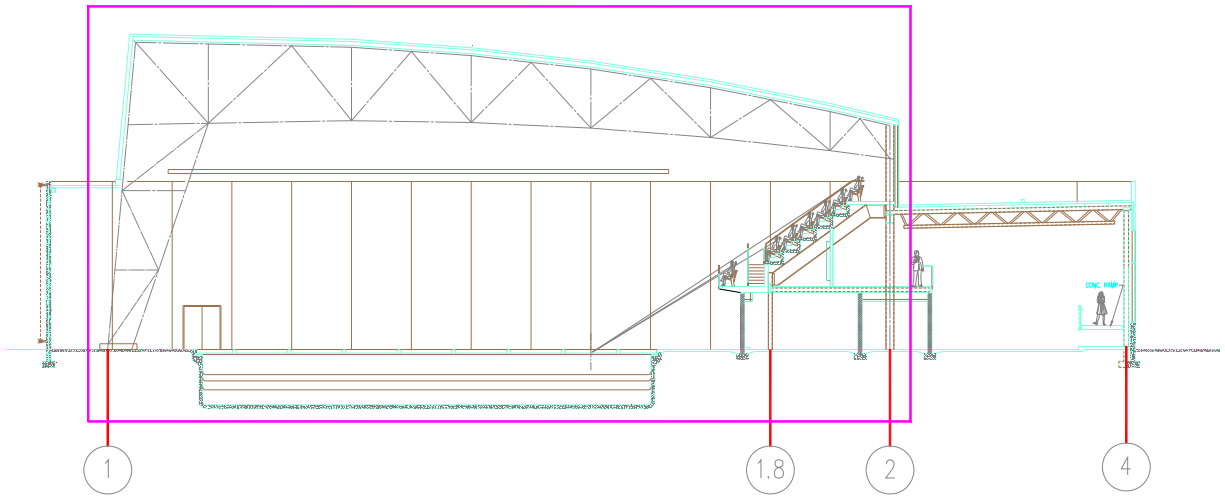

Figure 14 – “Building 1” – Enclosed in magenta-colored box

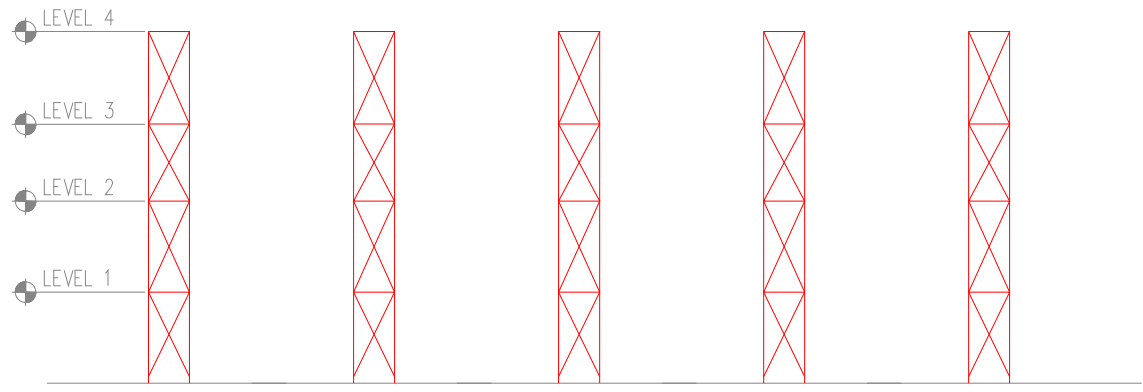

Figure 15 – “Building 1” – Steel Braced Frames at Column Line 1

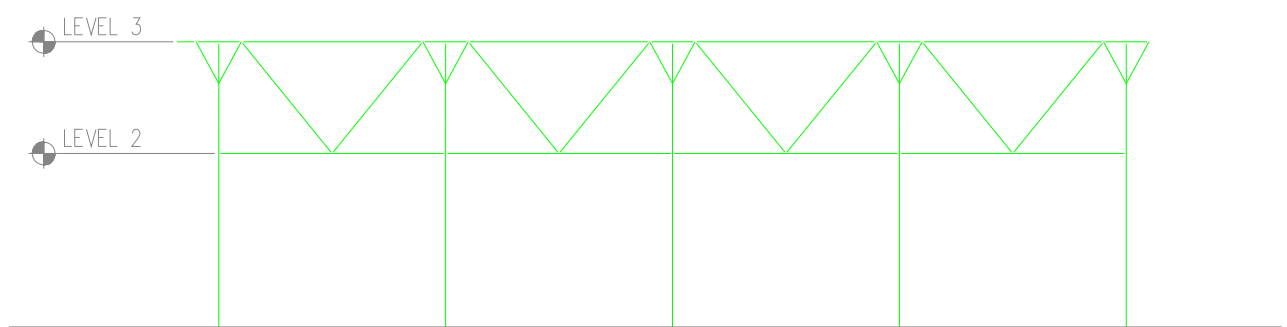

Figure 16 – “Building 1” – Steel Braced Frame at Column Line 2

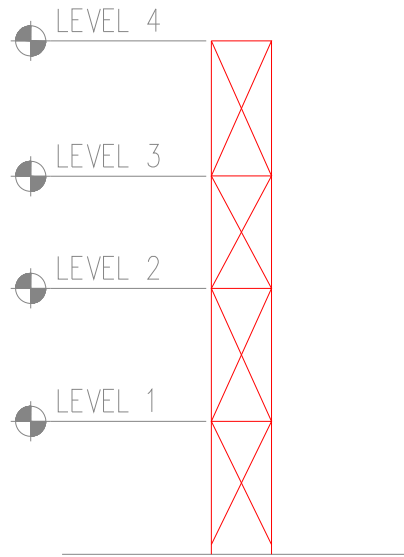

Figure 17 – “Building 1” – Steel Braced Frame at Column Line 1 used for 2D analysis

“Building 2” mainly consists of the concrete grandstand seating area which spans from column line 1.8 to column line 2 (see Figure 16 below). A moment frame is located at column line 1.8, and a braced frame is located at column line 2 (the same braced frame from “Building 1”). Each of these frames takes some of the seismic force caused by the grandstand. The moment frame at column line 1.8 takes all of the seismic force caused by the balcony at the bottom of the grandstand seating area. The frame at column line 2 takes wind load (from “Building 1”), however the frame at column line 1.8 will not see any wind load. An elevation of the moment frame at column line 1.8 is shown in Figure 17, and the frame at column line 2 is shown above in Figure 14.

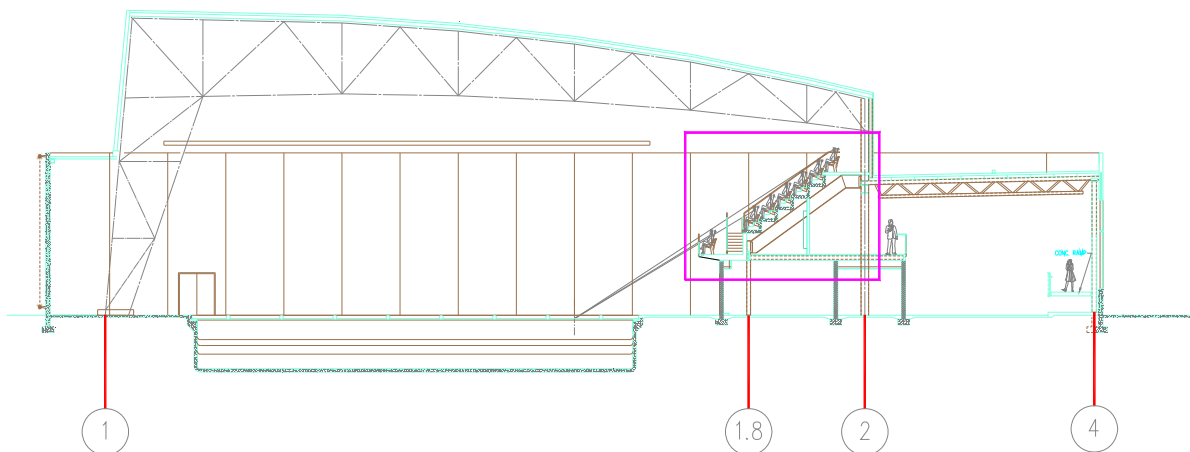

Figure 18 – “Building 2” – Enclosed in magenta-colored box

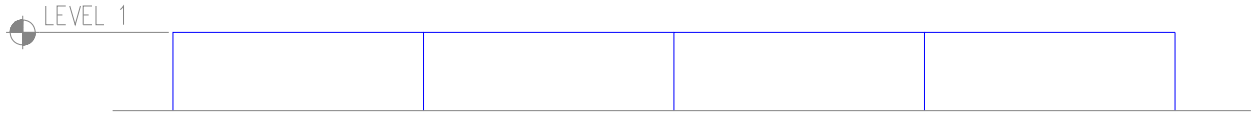

Figure 19 – “Building 2” – Steel Moment Frame at Column Line 1.8

“Building 3” mainly consists of the precast concrete hollow core floor planks. The concrete planks frame into the moment frame at column line 1.8 at one end. At the other end some of the concrete planks frame into four different shear walls that run in the North/South direction and are located slightly to the right of column line 2 (see Figure below). The shear walls do not run continuously along the entire span of the building, and the concrete planks are supported by lintels where there are no shear walls. Therefore, where the concrete planks rest on lintels on the eastward end it was assumed that the moment frame at column line 1.8 would take all of the seismic load from these concrete floor planks. Neither the moment frame at column line 1.8 nor the shear walls take any wind load.

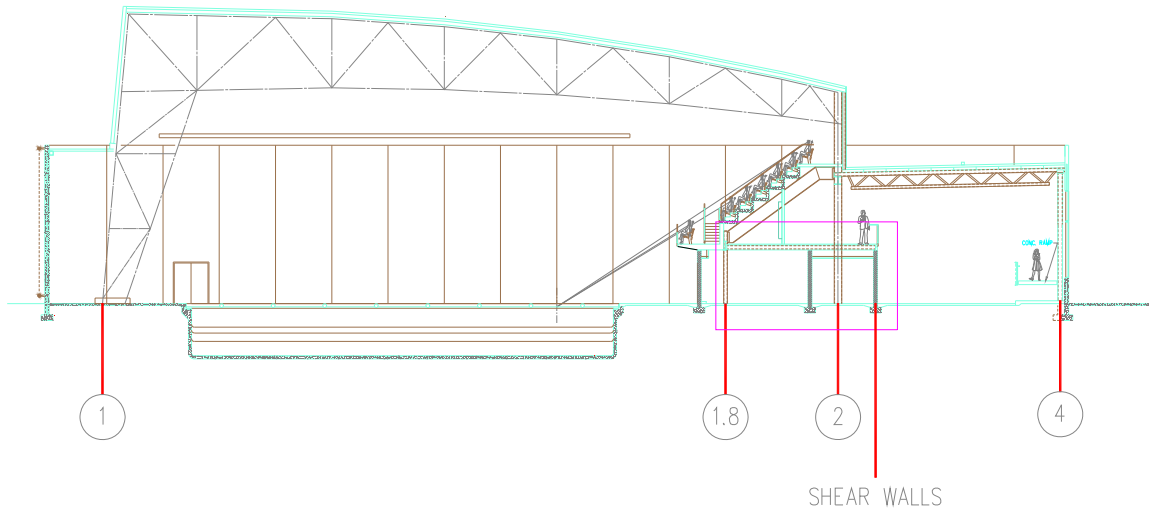

Figure 20 – “Building 3” – Enclosed in magenta-colored box

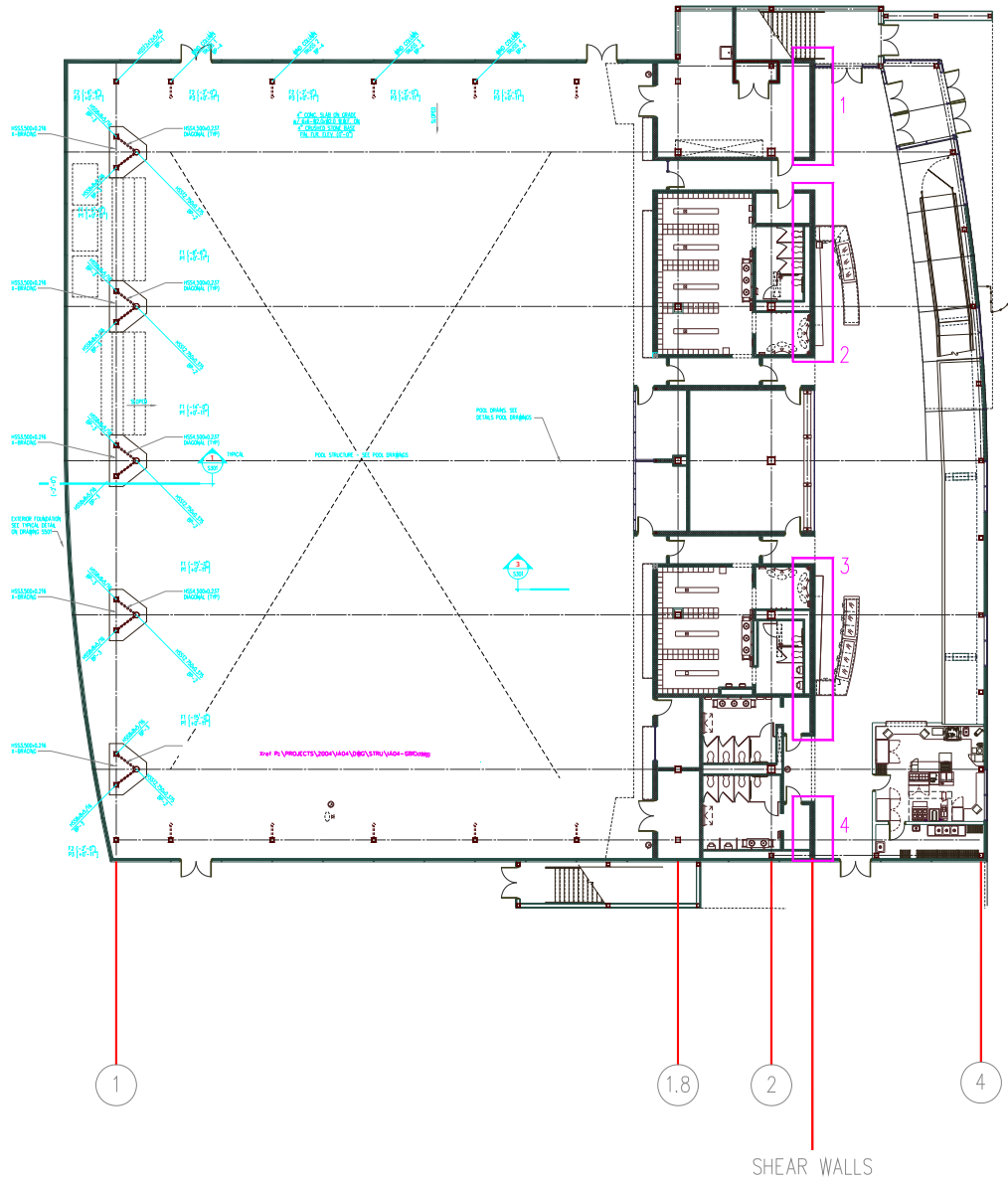

Figure 21 – “Building 3” – Plan view showing the four labeled shear walls

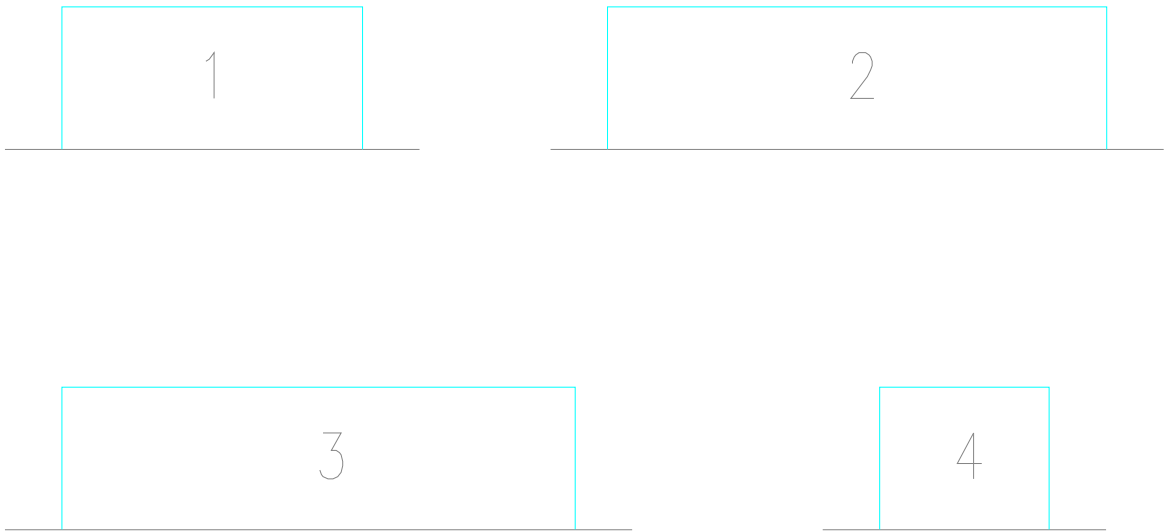

Figure 22 - Elevations of Shears Walls

”Building 4” is basically the entire lobby portion of the building, which includes the braced frame at column line 1.8 and a moment frame at column line 4. Seismic loads (mainly from the low roof above the lobby and precast concrete panels on the exterior face of the building) are distributed to both of these frames. Wind loads applied to the façade of the lobby portion of the building are also distributed to these two frames.

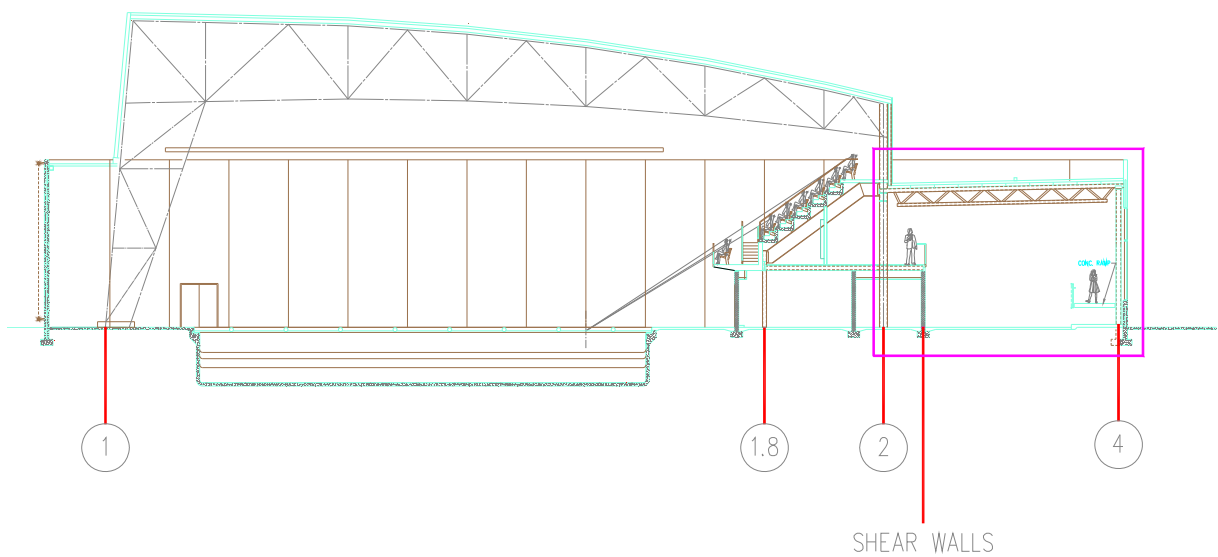

Figure 23 - “Building 4” – Enclosed in magenta-colored box

Codes and Standards

Below is a list of codes and standards applied to the original design and a list of codes that were substituted for Thesis analysis. The codes and standards applied to the original design were noted on Nutec's structural drawings. Also listed is a strength requirement summary of the materials used in the building.

Applied to Original Design:

International Building Code – 2003

“Building Code Requirements for Reinforced Concrete, ACI-318-99”, American Concrete Institute

“ACI Manual of Concrete Practice – Parts 1 through 5, 2002”, American Concrete Institute

“Manual of Standard Practice”, Concrete Reinforcing Steel Institute

“Manual of Steel Construction – Load and Resistance Factor Design”, Third Edition, American Institute of Steel Construction (including specification for structural steel buildings, specification for steel hollow structural sections, specification for single-angle members, specification for structural joints using ASTM A325 or A490 bolts, and AISC Code of Standard Practice)

“Hollow Structural Sections Connections Manual”, American Institute of Steel Construction

“Detailing for Steel Construction”, American Institute of Steel Construction

“Structural Welding Code ANSI/AWS D1.1-98”, American Welding Society

“Building Code Requirements for Masonry Structures”, (ACI 530-99/ASCE 5-99)

“Specifications for Masonry Structures”, (ACI 530.1-99/ASCE 6-99)

Substituted for Thesis Analysis:

International Building Code – 2006

ASCE 7-05

ACI 318-08

Material Strength Requirement Summary:

Cast-in-Place Concrete

Foundations:	4,000 psi
Slabs on Grade:	4,000 psi
Exposed to Freezing:	4,000 psi
Reinforcing Bars:	60 ksi

Structural Steel

Channels, Angles, and Plates:	36 ksi
Wide Flange Shapes:	50 ksi
Structural Tubing (Rectangular):	46 ksi
Structural Tubing (Round):	42 ksi
Structural Pipe:	35 ksi

Masonry

Compressive Strength:	2,000 psi
Reinforcing Bars:	60 ksi

Building Load Summary

Gravity Loads

Nutec Design Associates, Inc., used the 2003 International Building Code and the American Society of Civil Engineers (ASCE) 7-98 to determine gravity loads, while ASCE 7-05 was used to determine the gravity loads in this report. All reported loads are noted in Table 1. Snow load factors using ASCE 7-05 are shown in Table 2, and Table 3 shows a breakdown of the weights of the various components of the building.

Gravity Loads			
<i>Description</i>	<i>Nutec</i>	<i>ASCE 7-05</i>	<i>Design Value used for Thesis</i>
Dead (DL)			
Concrete	145 pcf	150 pcf	150 pcf
Live (LL)			
Roofs	30 psf + Drifted Snow	20 psf	20 psf + Drifted Snow
Grandstands	100 psf	100 psf	100 psf
Ramps, Corridor	100 psf	100 psf	100 psf
Mechanical Rooms	100 psf	?	100 psf
Snow (S)			
Snow	21 psf	23.1 psf	23.1 psf

Table 2 – Building Gravity Loads

*Nutec’s roof live load may have conservatively been taken to be 30 psf + drifted snow instead of 20 psf + drifted snow

*Nutec showed a Snow Load Importance Factor of 1.0 on the drawings. Nutec said this was a mistake and that the drawings should have shown a Snow Load Importance Factor of 1.1. The Nutec snow load of 21 psf in Table 1 was taken from the drawings, which incorporated the incorrect Snow Load Importance Factor of 1.0 instead of 1.1. Nutec’s values for C_e , C_t , and C_s matched those from ASCE 7-05. Hence, the Nutec snow load and the ASCE 7-05 snow load technically match, but Nutec’s drawings do not reflect this and only show a snow load of 21 psf.

Snow Loads	
Ground Snow Load, P_g	30 psf
Snow Exposure Factor, C_e	0.7
Thermal Factor, C_t	1.0
Snow Load Importance Factor, I	1.1
Flat Roof Snow Load, P_f	23.1 psf
Roof Slope Factor, C_s	1.0

Table 3 – Snow Load Factors using ASCE 7-05

*Roof Slope Factor, C_s , was conservatively taken to be 1.0 (Nutec also used $C_s = 1.0$)

Weights of Building Components	
Large Trusses and Supporting Columns	146.78 kips
Concrete Grandstand	331.52 kips
Concrete Balcony	129.89 kips
Concrete Ramp	107.04 kips
Hollow Core Concrete Planks	315.71 kips
(2) Stairs at Grandstand	28.48 kips
Concrete Stairs by Lobby	41.97 kips
Roofing	242.02 kips
Wind Column Trusses	30.25 kips
Trusses Above Lobby	22.23 kips
Gallery Level Framing (above lobby)	51.75 kips
Mechanical Unit Support Framing	18.92 kips
Mechanical Units	54.50 kips
Interior Walls (Ground Level)	271.77 kips
Interior Walls (Concourse Level)	179.81 kips
Precast Concrete Panels	1577.84 kips
Roofing above Lobby	304.20 kips
Precast Sill by Wind Trusses	66.89 kips
Roofing along Large Trusses	44.02 kips
Roofing along West Edge	59.21 kips
Columns in Lobby	37.22 kips
Sloped Beams Supporting Concrete Seating Area	9.09 kips
TOTAL	4071.12 kips

Table 4 – Weights of Building Components

Lateral Loads

Wind Loads

Method 2 – Analytical Procedure of ASCE 7-05 Section 6.5 was used to determine wind loads. Variables used in the wind calculation are located in Table 5 and wind loads are noted in Tables 6, 7, and 8.

Wind Variables			ASCE 7-05 Reference
Basic Wind Speed	V	90 mph	Figure 6-1 (p. 33)
Wind Directionality Factor	K_d	0.85	Table 6-4 (p. 80)
Importance Factor	I	1.15	Table 6-1 (p. 77)
Exposure Category		C	Sec. 6.5.6.3
Topographic Factor	K_{zt}	1.0	Sec. 6.5.7.1
Velocity Pressure Exposure Coefficient Evaluated at Height z	K_z	Varies	Table 3 (p. 79)
Velocity Pressure at Height z	q_z	Varies	Eq. 6-15
Velocity Pressure at Mean Roof Height h	q_h	22.337	Eq. 6-15
Equivalent Height of Structure	z	31.8	Table 6-2
Intensity of Turbulence	I_z	0.201	Eq. 6-5
Integral Length Scale of Turbulence	L_z	496.31'	Eq. 6-7
Background Response Factor (North/South)	Q	0.8468	Eq. 6-6
Background Response Factor (East/West)	Q	0.8558	Eq. 6-6
Gust Effect Factor (North/South)	G_f	0.956	Eq. 6-4
Gust Effect Factor (East/West)	G_f	0.966	Eq. 6-4
External Pressure Coefficient (Windward)	C_p	0.8	Figure 6-6 (p. 49)
External Pressure Coefficient (N/S Leeward)	C_p	-0.5	Figure 6-6 (p. 49)
External Pressure Coefficient (E/W Leeward)	C_p	-0.4654	Figure 6-6 (p. 49)

Table 5 – Wind Variables

"Building 1" - Wind Loads (North/South Direction) B=183'-0", L=156'-0"																
Level	Height Above Ground - z (ft)	Story Height (ft)	K _z	q _z	Wind Pressure (psf)				Total Pressure (psf)	Force (k) of Windward Only	Force (k) of Total Pressure	Story Shear Windward (k)	Story Shear Total (k)	Moment Windward (ft-k)	Moment Total (ft-k)	
					Windward	Leeward	Side Walls	Roof								
4	53.0	15.3	1.102	22.34	16.40	-10.68	-14.95	-23.24	27.08	8.50	14.03	8.50	14.03	450.48	743.80	
3	37.7	13.0	1.026	20.80	15.27	-10.68	-14.95	-23.24	25.94	26.49	45.01	34.99	59.05	1317.84	2224.03	
2	24.7	14.2	0.937	19.00	13.95	-10.68	-14.95	-23.24	24.62	25.65	45.28	60.64	104.33	1495.68	2573.43	
1	10.5	10.5	0.85	17.23	12.65	-10.68	-14.95	-23.24	23.33	21.85	40.30	82.49	144.63	866.12	1518.58	
sum(Story Shear (Windward))=82.49 k					sum (Story Shear (Total))=144.63 k											
sum(Moment (Windward))=4234.49 ft-k					sum (Moment (Total))=7059.84 ft-k											

Table 6 - Wind Loads to Indoor Pool Area – N/S direction (these loads are applied to the braced frame at column line 1 and the braced frame at column line 2)



Figure 26 – “Building 1” Wind Loads (North/South)

"Building 4" - Wind Loads (North/South Direction) B=183'-0", L=156'-0"																
Floor	Height Above Ground - z (ft)	Story Height (ft)	K _z	q _z	Wind Pressure (psf)				Total Pressure (psf)	Force (k) of Windward Only	Force (k) of Total Pressure	Story Shear Windward (k)	Story Shear Total (k)	Moment Windward (ft-k)	Moment Total (ft-k)	
					Windward	Leeward	Side Walls	Roof								
3	37.7	13.0	1.026	20.80	15.27	-10.68	-14.95	-23.24	25.94	2.53	4.19	2.53	4.19	95.12	157.69	
2	24.7	14.2	0.937	19.00	13.95	-10.68	-14.95	-23.24	24.62	8.41	14.47	10.94	18.66	269.84	460.24	
1	10.5	10.5	0.85	17.23	12.65	-10.68	-14.95	-23.24	23.33	5.66	10.15	16.59	28.80	174.24	302.44	
sum(Story Shear (Windward))=16.59 k					sum (Story Shear (Total))=28.80 k											
sum(Moment (Windward))=539.20 ft-k					sum (Moment (Total))=920.37 ft-k											

Table 7 - Wind Loads to Lobby Area – N/S direction (these loads are applied to the braced frame at column line 2 and the moment frame at column line 4)



Figure 27 – “Building 4” Wind Loads (North/South)

Wind Loads (East/West Direction) B=156'-0", L=183'-0"																
Floor	Height Above Ground - z (ft)	Story Height (ft)	K _z	q _z	Wind Pressure (psf)				Total Pressure (psf)	Force (k) of Windward Only	Force (k) of Total Pressure	Story Shear Windward (k)	Story Shear Total (k)	Moment Windward (ft-k)	Moment Total (ft-k)	
					Windward	Leeward	Side Walls	Roof								
4	53.0	15.3	1.102	22.34	16.48	-10.04	-15.10	-23.45	26.53	38.01	61.16	38.01	61.16	2014.48	3241.72	
3	37.7	13.0	1.026	20.80	15.35	-10.04	-15.10	-23.45	25.39	30.90	51.12	68.91	112.29	2595.64	4229.44	
2	24.7	14.2	0.937	19.00	14.02	-10.04	-15.10	-23.45	24.06	33.59	57.65	102.50	169.94	2528.44	4191.86	
1	10.5	10.5	0.85	17.23	12.71	-10.04	-15.10	-23.45	22.76	23.42	41.92	125.92	211.86	1322.19	2224.48	
sum(Story Shear (Windward))=125.92 k					sum (Story Shear (Total))=211.86 k											
sum(Moment (Windward))=8460.75 ft-k					sum (Moment (Total))=13887.50 ft-k											

Table 8 - Wind Loads to Entire Building – E/W direction (these loads are applied to the five truss frames)

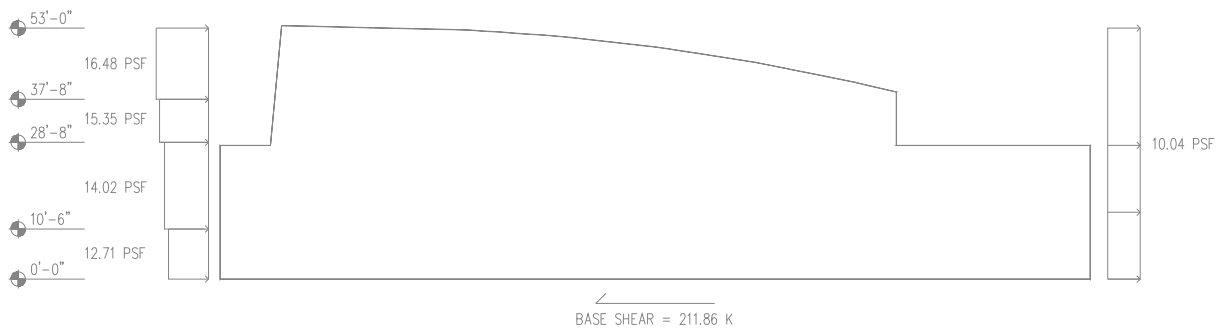

Figure 28 – Winds Loads on Entire Building (East/West)

Seismic Loads

Seismic Design Variables			ASCE Reference
Site Classification		B	
Occupancy Category		III	
Structural System		Steel Systems Not Specifically Detailed for Seismic Resistance, Excluding Cantilever Column Systems	Table 12.2-1
Spectral Response Acceleration, Short Period	S_S	0.2	Figure 22-1
Spectral Response Acceleration, 1-Second Period	S_1	0.054	Figure 22-2
Site Coefficient	F_a	1.2	Table 11.4-1
Site Coefficient	F_v	1.7	Table 11.4-2
MCE Spectral Response Acceleration, Short Period	S_{MS}	0.24	Eq. 11.4-1
MCE Spectral Response Acceleration, 1-Second Period	S_{M1}	0.0918	Eq. 11.4-2
Design Spectral Acceleration, Short Period	S_{DS}	0.16	Eq. 11.4-3
Design Spectral Acceleration, 1-Second Period	S_{D1}	0.0612	Eq. 11.4-4
Seismic Design Category	SDC	A	Table 11.6-1
Response Modification Coefficient	R	3	Table 12.2-1
Importance Factor	I	1.25	Table 11.5-1
Approximate Period Parameter	C_t	0.02	Table 12.8-2
Building Height (above grade)	h_n	53 ft	
Approximate Period Parameter	x	0.75	Table 12.8-2
Approximate Fundamental Period	T_a	0.3929	Eq. 12.8-7
Long Period Transition Period	T_L	6 sec	Figure 22-15
Calculated Period Upper Limit Coefficient	C_u	1.7	Table 12.8-1
Fundamental Period	T	0.3929	
Seismic Response Coefficient	C_s	0.006491	Eq. 12.8-2
Structure Period Exponent	k	1.0	

Table 9 - Seismic Design Variables

Seismic Loads - "Building 1"								
Level	Story Weight w_x	Height h_x (ft)	h_x^k	$w_x h_x^k$	C_{vx}	Lateral Force F_x	Story Shear V_x	Moments M_x (ft-k)
4	259.10	53.00	53.00	13732.14	0.346	33.99	0.00	1801.26
3	163.12	37.67	37.67	6144.15	0.155	15.21	33.99	572.77
2	589.05	24.67	24.67	14529.85	0.366	35.96	49.19	887.02
1	501.28	10.50	10.50	5263.41	0.133	13.03	85.15	136.78
sum($w_x h_x^k$)= 39669.55		sum(F_x)=V= 98.18 kips			sum(M_x)= 3397.82			
Total Weight of "Building 1" (Above Grade) = 1512.54 kips								

Table 10 – Seismic Loads – “Building 1”

$$V = (C_s)(W) = (0.06491)(1512.54 \text{ kips}) = 98.18 \text{ kips}$$

$$C_{vx} = w_x h_x^k / \text{sum}(w_i h_i^k)$$



Figure 29 – “Building 1” Seismic Loads

Seismic Loads - "Building 2"									
Level	Story Weight w_x	Height h_x (ft)	h_x^k	$w_x h_x^k$	C_{vx}	Lateral Force F_x	Story Shear V_x	Moments M_x (ft-k)	
4	0.00	53.00	53.00	0.00	0.000	0.00	0.00	0.00	
3	0.00	37.67	37.67	0.00	0.000	0.00	0.00	0.00	
2	329.78	24.67	24.67	8134.55	0.703	29.99	0.00	739.69	
1	327.51	10.50	10.50	3438.89	0.297	12.68	29.99	133.11	
sum($w_x h_x^k$)=		11573.44	sum(F_x)=V=		42.66 kips		sum(M_x)=		872.80
Total Weight of "Building 2" (Above Grade) =					657.29 kips				

Table 11 – Seismic Loads – “Building 2”

$$V = (C_s)(W) = (0.06491)(657.29 \text{ kips}) = 42.66 \text{ kips}$$

$$C_{vx} = w_x h_x^k / \text{sum}(w_i h_i^k)$$



Figure 30 – “Building 2” Seismic Loads

Seismic Loads - "Building 3"								
Level	Story Weight w_x	Height h_x (ft)	h_x^k	$w_x h_x^k$	C_{vx}	Lateral Force F_x	Story Shear V_x	Moments M_x (ft-k)
4	0.00	53.00	53.00	0.00	0.000	0.00	0.00	0.00
3	0.00	37.67	37.67	0.00	0.000	0.00	0.00	0.00
2	0.00	24.67	24.67	0.00	0.000	0.00	0.00	0.00
1	1089.54	10.50	10.50	11440.17	1.000	70.72	0.00	742.58
sum($w_x h_x^k$)= 11440.17		sum(F_x)=V= 70.72 kips					sum(M_x)= 742.58	
Total Weight of "Building 3" (Above Grade) = 1089.54 kips								

Table 12 – Seismic Loads – “Building 3”

$$V = (C_s)(W) = (0.06491)(1089.54\text{kips}) = 70.72 \text{ kips}$$

$$C_{vx} = w_x h_x^k / \text{sum}(w_i h_i^k)$$



Figure 31 – “Building 3” Seismic Loads

Seismic Loads - "Building 4"									
Level	Story Weight w_x	Height h_x (ft)	h_x^k	$w_x h_x^k$	C_{vx}	Lateral Force F_x	Story Shear V_x	Moments M_x (ft-k)	
4	0.00	53.00	53.00	0.00	0.000	0.00	0.00	0.00	
3	0.00	37.67	37.67	0.00	0.000	0.00	0.00	0.00	
2	760.65	24.67	24.67	18762.70	1.000	49.3738	0.00	1217.89	
1	0.00	10.50	10.50	0.00	0.000	0.00	49.37	0.00	
sum($w_x h_x^k$)=		18762.70	sum(F_x)=V=		49.37 kips		sum(M_x)=		1217.89
Total Weight of "Building 4" (Above Grade) =					760.65 kips				

Table 13 – Seismic Loads – “Building 4”

$$V = (C_s)(W) = (0.06491)(760.65 \text{ kips}) = 49.37 \text{ kips}$$

$$C_{vx} = w_x h_x^k / \text{sum}(w_i h_i^k)$$



Figure 32 – “Building 4” Seismic Loads

SAP Models

Two-dimensional SAP models of each lateral force resisting frame were made and used to determine drifts, story drifts, member axial forces, and member bending moments. The truss had to be modeled in 3D due to the orientation of the elements making up the truss, but the truss was still treated as a 2D frame when applying loads and determining displacements. The shear walls were not modeled in SAP since they were not one of the main lateral force resisting systems in the building. Images of the SAP models are shown below in Figures 33-37.

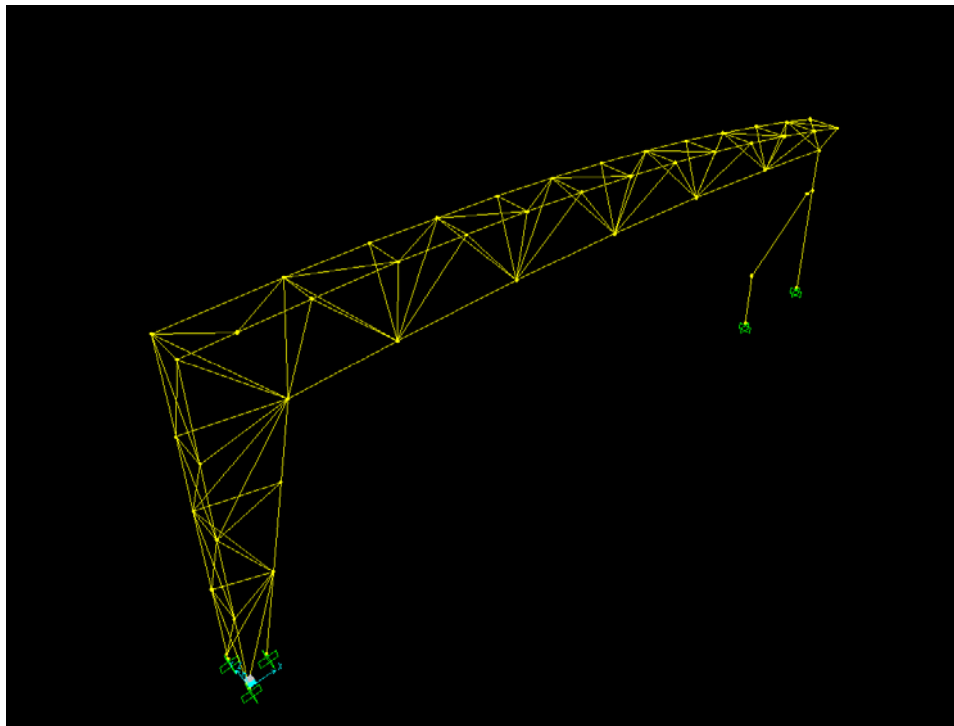

Figure 33 - SAP Model of Truss/Moment Frame

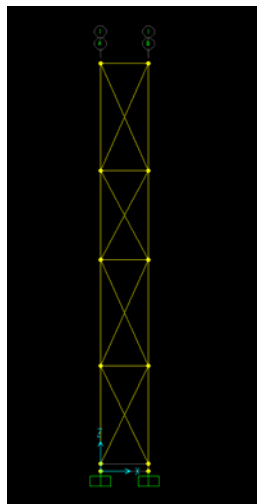

Figure 34 – SAP Model of Braced Frame at Column Line 1

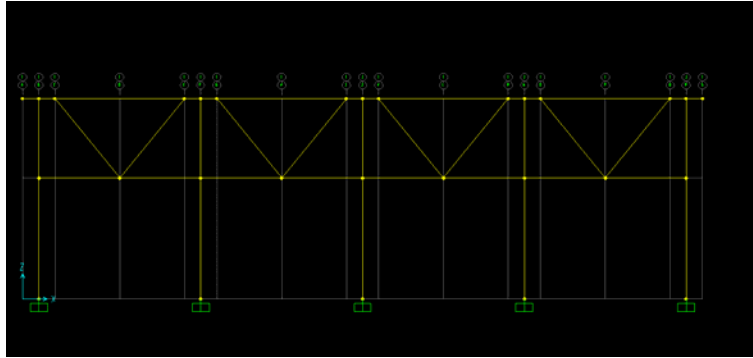

Figure 35 – SAP Model of Braced Frame at Column Line 2

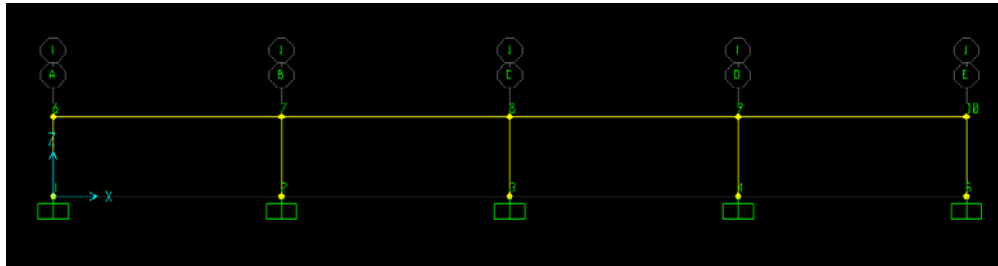

Figure 36 – SAP Model of Braced Frame at Column Line 1.8

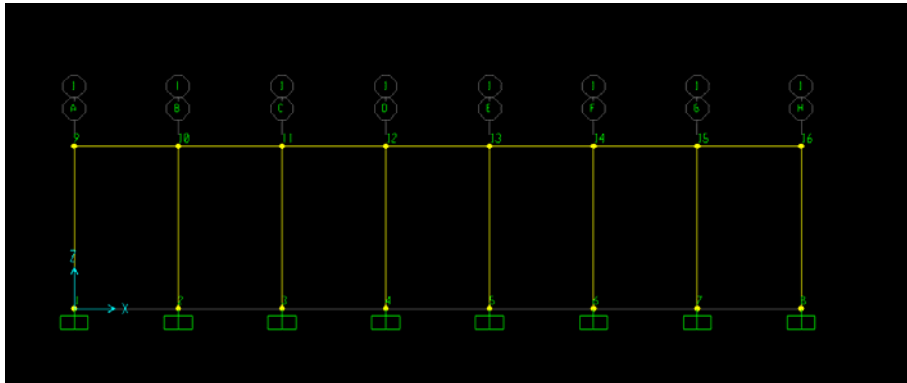

Figure 37 - SAP Model of Braced Frame at Column Line 4

Stiffness Values

The stiffness of each frame at each applicable level was determined by applying a 1 kip load to the frame at that particular level and determining the displacement of the frame at that level. SAP was used to determine the displacements. The stiffness is equal to the 1 kip load divided by the displacement.

$$k = P/\Delta$$

Stiffness Values (k-values) - North/South Direction				
	Level	P (kips)	Deflection (in.)	k = P/Defl. (kip/in)
Braced Frame - Column Line 1	1	1	0.011196	89.318
Braced Frame - Column Line 1	2	1	0.034044	29.374
Braced Frame - Column Line 1	3	1	0.070259	14.233
Braced Frame - Column Line 1	4	1	0.149424	6.692
Moment Frame - Column Line 1.8	1	1	0.001422	703.235
Braced Frame - Column Line 2	2	1	0.007625	131.148
Braced Frame - Column Line 2	3	1	0.009952	100.482
Braced Frame - Column Line 4	2	1	0.046756	21.388

Table 14 – Stiffness Values for Steel Braced Frames and Steel Moment Frames – North/South Direction

Since the shear walls were not modeled in SAP, the deflections due to a 1-kip load were calculated by hand.

$$\Delta_p = [(Ph^3)/(3EI)] + [(2.78Ph)/(AE)]$$

$$E = 57,000\sqrt{f'_c} = 57,000\sqrt{(4000 \text{ psi})} = 3,604,997 \text{ psi} = 3,605 \text{ ksi}$$

Stiffness Values (k-values) - North/South Direction								
Shear Wall	h (in.)	t (in.)	L (in)	A = (L)(t)	I = ((t)(L^3))/12 (in ⁴)	P (kips)	Defl. = ((P)(h^3)/(3EI)) + ((2.78Ph)/(AE)) (in)	k = P/Defl. (kip/in)
1	112	11.625	236	2743.50	12733498	1	0.00004168	23990.477
2	112	11.625	392	4557.00	58353904	1	0.00002118	47216.112
3	112	11.625	403	4684.88	63405488.66	1	0.00002048	48817.348
4	112	11.625	133	1546.13	2279117.094	1	0.00011286	8860.549

Table 15 – Stiffness Values for Shear Walls – North/South Direction

Stiffness Values (k-values) - East/West Direction				
	Level	P (kips)	Deflection (in.)	k = P/Defl. (kip/in)
Truss/Moment Frame	1	1	0.002555	391.389
Truss/Moment Frame	2	1	0.004812	207.814
Truss/Moment Frame	3	1	0.013429	74.466
Truss/Moment Frame	4	1	0.015192	65.824

Table 16 – Stiffness Values for Trusses/Moment Frames – East/West Direction

Load Combinations

Load combinations from ASCE 7-05 that were used for the lateral load analysis of each frame are as follows:

$$1.4(D + F)$$

$$1.2(D + F + T) + 1.6(L + H) + 0.5(L_r \text{ or } S \text{ or } R)$$

$$1.2D + 1.6(L_r \text{ or } S \text{ or } R) + (L \text{ or } 0.8W)$$

$$1.2D + 1.6W + L + 0.5(L_r \text{ or } S \text{ or } R)$$

$$1.2D + 1.0E + L + 0.2S$$

$$0.9D + 1.6W + 1.6H$$

$$0.9D + 1.0E + 1.6H$$

In general, $1.2D + 1.6W + L + 0.5(L_r \text{ or } S \text{ or } R)$ tended to control the indoor pool area due to the large surface area of exterior walls and low weight of building materials in this area. On the other hand, $1.2D + 1.0E + L + 0.2S$ mostly controlled the frames affected by the high seismic forces caused by the precast concrete hollow core floor planks, the precast concrete balcony, and the precast concrete grandstand. Sometimes the forces from one load combination controlled the load applied to one level of a frame, but the forces caused by the other load combination controlled the load applied to another level of the same frame. Therefore, each of the two load cases was applied to each frame, and the resulting drifts and displacements were determined and checked against the limits set forth by ASCE 7-05.

Center of Mass

The center of mass at each level was determined by hand. Tributary areas were used for building elements that did not exactly line up with a level or that crossed over several levels. The reference point used for the center of mass was the Southwest corner of the facade of the building. Center of mass values for each level are found in Tables 17-20 below. Calculations for the center of mass at each level are found in Appendix A.

Center of Mass x = $\{\sum[(\text{weight})(x)]\}/\sum\text{weight}$

Center of Mass y = $\{\sum[(\text{weight})(y)]\}/\sum\text{weight}$

Center of Mass - Entire Building - Level 1			
	Weight (kips)	Center of Mass	
		x (ft)	y (ft)
Building 1 - Level 1	501.277	31.4344	80.7575
Building 2 - Level 1	327.513	113.7793	78.0000
Building 3 - Level 1	1089.540	125.7532	78.2569
TOTAL=	1918.330	99.0625	78.8665

Table 17 – Center of Mass of Entire Building at Level 1

Center of Mass - Entire Building - Level 2			
	Weight (kips)	Center of Mass	
		x (ft)	y (ft)
Building 1 - Level 2	589.048	35.8686	81.4001
Building 2 - Level 2	329.779	124.6779	75.2708
Building 4 - Level 2	760.650	151.5495	75.1941
TOTAL=	1679.477	105.6999	77.3858

Table 18 – Center of Mass of Entire Building at Level 2

Center of Mass - Entire Building - Level 3			
	Weight (kips)	Center of Mass	
		x (ft)	y (ft)
Building 1 - Level 3	163.119	92.0275	78.0000
TOTAL=	163.119	92.0275	78.0000

Table 19 – Center of Mass of Entire Building at Level 3

Center of Mass - Entire Building - Level 4			
	Weight (kips)	Center of Mass	
		x (ft)	y (ft)
Building 1 - Level 4	259.097	46.0581	78.0000
TOTAL=	259.097	46.0581	78.0000

Table 20 – Center of Mass of Entire Building at Level 4

Center of Rigidity

The center of rigidity was calculated for each level using the stiffness values of the frames that contribute to that level. The reference point used for the center of rigidity was the Southwest corner of the facade of the building (the same as the used for the center of mass). The center of rigidity at each level for the North/South direction is found in Tables 21-24, and the center of rigidity for the East/West direction is found in Tables 25-28 below. Table 29 shows the overall center of rigidity at each level.

$$\text{Center of Rigidity (x)} = [\text{sum}(k_{iy}x_i)]/[\text{sum}(k_{iy})]$$

Center of Rigidity - North/South Direction - Entire Building - Level 1					
	k_{iy}	x_i (ft)	Quantity	$(k_{iy}x_i)$	Center of Rigidity x (ft)
Braced Frames - Column Line 1	89.318	1.1510	5	514.0415	
Moment Frame - Column Line 1.8	703.235	111.9010	1	78692.7157	
TOTAL=	1149.823		TOTAL=	79206.7572	68.8860

Table 21 – Center of Rigidity for North/South Direction – Level 1

Center of Rigidity - North/South Direction - Entire Building - Level 2					
	k_{iy}	x_i (ft)	Quantity	$(k_{iy}x_i)$	Center of Rigidity x (ft)
Braced Frames - Column Line 1	29.374	1.1510	5	169.0521	
Braced Frame - Column Line 2	131.148	130.3177	1	17090.8470	
Moment Frame - Column Line 4	21.388	171.6510	1	3671.2089	
TOTAL=	299.404		TOTAL=	20931.1079	69.9093

Table 22 – Center of Rigidity for North/South Direction – Level 2

Center of Rigidity - North/South Direction - Entire Building - Level 3					
	k_{iy}	x_i (ft)	Quantity	$(k_{iy}x_i)$	Center of Rigidity x (ft)
Braced Frames - Column Line 1	14.233	1.1510	5	81.9142	
Braced Frame - Column Line 2	100.482	130.3177	1	13094.6250	
TOTAL=	171.648		TOTAL=	13176.5392	76.7651

Table 23 – Center of Rigidity for North/South Direction – Level 3

Center of Rigidity - North/South Direction - Entire Building - Level 4					
	k_{iy}	x_i (ft)	Quantity	$(k_{iy}x_i)$	Center of Rigidity x (ft)
Braced Frames - Column Line 1	6.692	1.1510	5	38.5160	
TOTAL=	33.462		TOTAL=	38.5160	1.1510

Table 24 – Center of Rigidity for North/South Direction – Level 4

$$\text{Center of Rigidity (y)} = [\text{sum}(k_{ix}y_i)]/[\text{sum}(k_{ix})]$$

Center of Rigidity - East/West Direction - Entire Building - Level 1					
	k_{ix}	y_i (ft)	Quantity	$(k_{ix}y_i)$	Center of Rigidity y (ft)
Truss/Moment Frame	391.389	18.0000	1	7045.0020	
Truss/Moment Frame	391.389	48.0000	1	18786.6720	
Truss/Moment Frame	391.389	78.0000	1	30528.3420	
Truss/Moment Frame	391.389	108.0000	1	42270.0120	
Truss/Moment Frame	391.389	138.0000	1	54011.6820	
TOTAL=	1956.945		TOTAL=	152641.7100	78.0000

Table 25 – Center of Rigidity for East/West Direction – Level 1

Center of Rigidity - East/West Direction - Entire Building - Level 2					
	k_{ix}	y_i (ft)	Quantity	$(k_{ix}y_i)$	Center of Rigidity y (ft)
Truss/Moment Frame	207.814	18.0000	1	3740.6520	
Truss/Moment Frame	207.814	48.0000	1	9975.0720	
Truss/Moment Frame	207.814	78.0000	1	16209.4920	
Truss/Moment Frame	207.814	108.0000	1	22443.9120	
Truss/Moment Frame	207.814	138.0000	1	28678.3320	
TOTAL=	1039.070		TOTAL=	81047.4600	78.0000

Table 26 – Center of Rigidity for East/West Direction – Level 2

Center of Rigidity - East/West Direction - Entire Building - Level 3					
	k_{ix}	y_i (ft)	Quantity	$(k_{ix}y_i)$	Center of Rigidity y (ft)
Truss/Moment Frame	74.446	18.0000	1	1340.0280	
Truss/Moment Frame	74.446	48.0000	1	3573.4080	
Truss/Moment Frame	74.446	78.0000	1	5806.7880	
Truss/Moment Frame	74.446	108.0000	1	8040.1680	
Truss/Moment Frame	74.446	138.0000	1	10273.5480	
TOTAL=	372.230		TOTAL=	29033.9400	78.0000

Table 27 – Center of Rigidity for East/West Direction – Level 3

Center of Rigidity - East/West Direction - Entire Building - Level 4					
	k_{ix}	y_i (ft)	Quantity	$(k_{ix}y_i)$	Center of Rigidity y (ft)
Truss/Moment Frame	65.824	18.0000	1	1184.8320	
Truss/Moment Frame	65.824	48.0000	1	3159.5520	
Truss/Moment Frame	65.824	78.0000	1	5134.2720	
Truss/Moment Frame	65.824	108.0000	1	7108.9920	
Truss/Moment Frame	65.824	138.0000	1	9083.7120	
TOTAL=	329.120		TOTAL=	25671.3600	78.0000

Table 28 – Center of Rigidity for East/West Direction – Level 4

Center of Rigidity - Entire Building		
Level	Center of Rigidity	
	x (ft)	y (ft)
1	68.8860	78.0000
2	69.9093	78.0000
3	76.7651	78.0000
4	1.1510	78.0000

Table 29 – Center of Rigidity for Entire Building at Each Level

Shear

Direct Shear

The direct shear values for each lateral force resisting frame and each level were calculated by hand and are found in Tables 30-39 below. Calculations for direct shear are found in Appendix B.

$$\text{Direct Load: } F_{iy} = (k_{iy}/(\sum k_{iy})) (P_y)$$

Due to Seismic Loads:

$$1.2D + 1.0E + L + 0.2S$$

North/South Direction:

Direct Shear - North/South Direction - "Building 1"								
Load Combination = 1.2D+1.0E+L+0.2S	Force (k)	Factored Force (k)	Distributed Force (kips)					
			Braced Frame - Column Line 1 - Level 1	Braced Frame - Column Line 1 - Level 2	Braced Frame - Column Line 1 - Level 3	Braced Frame - Column Line 1 - Level 4	Braced Frame - Column Line 2 - Level 2	Braced Frame - Column Line 2 - Level 3
Level 1	13.03	13.03	2.61					
Level 2	35.96	35.96		3.80				16.96
Level 3	15.21	15.21			1.26			8.90
Level 4	33.99	33.99				6.80		

Table 30 – Direct Shear Values due to Seismic Loads for “Building 1”

Direct Shear - North/South Direction - "Building 2"				
Load Combination = 1.2D+1.0E+L+0.2S	Force (k)	Factored Force (k)	Distributed Force (kips)	
			Moment Frame - Column Line 1.8 - Level 1	Braced Frame - Column Line 2 - Level 2
Level 1	29.17	29.17	29.17	
Level 2	69.01	69.01		69.01

Table 31 – Direct Shear Values due to Seismic Loads for “Building 2”

Direct Shear - North/South Direction - "Building 3"							
Load Combination = 1.2D+1.0E+L+0.2S	Force (k)	Factored Force (k)	Distributed Force (kips)				
			Moment Frame - Column Line 1.8 - Level 1	Shear Wall 1 - Level 1	Shear Wall 2 - Level 1	Shear Wall 3 - Level 1	Shear Wall 4 - Level 1
Level 1*	10.40	10.40	10.40				
Level 1	60.32	60.32	0.33	11.17	21.98	22.72	4.13
TOTAL=	70.72	TOTAL=	10.73	11.17	21.98	22.72	4.13

Table 32 – Direct Shear Values due to Seismic Loads for “Building 3”

*Assuming that 160.248 kips (or 10.40 kips of seismic force) must go to the moment frame at column line 1.8 – level 1 (there are areas where the precast hollow core concrete floor planks have no shear walls to frame into, so since they frame into the moment frame at column line 1.8 as well it is assumed that this moment frame will take all of the seismic load from the concrete planks at these areas)

Direct Shear - North/South Direction - "Building 4"				
Load Combination = 1.2D+1.0E+L+0.2S	Force (k)	Factored Force (k)	Distributed Force (kips)	
			Braced Frame - Column Line 2 - Level 2	Braced Frame - Column Line 4 - Level 2
Level 2	49.37	49.37	42.45	6.92

Table 33 – Direct Shear Values due to Seismic Loads for “Building 4”

Total Direct Shear - North/South Direction							
Load Combination = 1.2D+1.0E+L+0.2S	Distributed Force (kips)						
	Braced Frame - Column Line 1 - Level 1	Braced Frame - Column Line 1 - Level 2	Braced Frame - Column Line 1 - Level 3	Braced Frame - Column Line 1 - Level 4	Braced Frame - Column Line 2 - Level 2	Braced Frame - Column Line 2 - Level 3	Braced Frame - Column Line 4 - Level 2
Level 1	2.61						
Level 2		3.80			128.42		6.92
Level 3			1.26			8.90	
Level 4				6.80			

Table 34 – Direct Shear Values due to Seismic Loads for “Building 4” (North/South)

East/West Direction:

Total Direct Shear - East/West Direction					
Load Combination = 1.2D+1.0E+L+0.2S	Force (k)	Factored Force (k)	Distributed Force (kips)		
			Truss/Moment Frame (1 of 5)	Truss/Moment Frame - Joint at Column Line 1.8 (1 of 5)	Truss/Moment Frame - Joint at Column Line 2 (1 of 5)
Level 1	112.92	112.92	2.61	14.14	
Level 2	154.34	154.34	7.19		23.68
Level 3	15.21	15.21	3.04		
Level 4	33.99	33.99	6.80		

Table 35 – Direct Shear Values due to Seismic Loads for Entire Building (East/West)

Due to Wind Loads:

$$1.2D + 1.6W + L + 0.5(Lr \text{ or } S \text{ or } R)$$

North/South Direction:

Direct Shear - North/South Direction - "Building 1"							
Load Combination = 1.2D+1.6W+L+0.5 (Lr or S or R)	Force (k)	Distributed Force (kips)					
		Braced Frame - Column Line 1 - Level 1	Braced Frame - Column Line 1 - Level 2	Braced Frame - Column Line 1 - Level 3	Braced Frame - Column Line 1 - Level 4	Braced Frame - Column Line 2 - Level 2	Braced Frame - Column Line 2 - Level 3
Level 1	40.30	8.06					
Level 2	45.50		4.81			21.46	
Level 3	45.01			3.73			26.35
Level 4	14.03				2.81		

Table 36 – Direct Shear Values due to Wind Loads for “Building 1” (North/South)

Direct Shear - North/South Direction - "Building 4"				
Load Combination = 1.2D+1.6W+L+0.5 (Lr or S or R)	Force (k)	Distributed Force (kips)		
		Braced Frame - Column Line 2 - Level 2	Braced Frame - Column Line 2 - Level 3	Moment Frame - Column Line 4 - Level 2
Level 2	16.36	14.06	2.29	
Level 3	0.43			0.43

Table 37 – Direct Shear Values due to Wind Loads for “Building 4” (North/South)

Total Direct Shear - North/South Direction							
Load Combination = 1.2D+1.6W+L+0.5 (Lr or S or R)	Distributed Force (kips)						
	Braced Frame - Column Line 1 - Level 1	Braced Frame - Column Line 1 - Level 2	Braced Frame - Column Line 1 - Level 3	Braced Frame - Column Line 1 - Level 4	Braced Frame - Column Line 2 - Level 2	Braced Frame - Column Line 2 - Level 3	Braced Frame - Column Line 4 - Level 2
Level 1	12.90						
Level 2		7.69			56.85		3.67
Level 3			5.97			42.85	
Level 4				4.49			

Table 38 – Total Direct Shear Values due to Wind Loads (North/South)

East/West Direction:

Total Direct Shear - East/West Direction			
Load Combination = 1.2D+1.6W+L+0.5(Lr or S or R)	Force (k)	Factored Force (k)	Distributed Force (kips)
			Truss/Moment Frame (1 of 5)
Level 1	50.86	81.37	16.27
Level 2	53.38	85.41	17.08
Level 3	56.06	89.69	17.94
Level 4	30.58	48.93	9.79

Table 39 – Total Direct Shear Values due to Wind Loads (East/West)

Torsional Shear

The torsional shear values for each lateral force resisting frame and each level were calculated by hand and are found in Tables 40-51 below. Rather than breaking up the building into the four different “buildings” as was done when determining the direct shear values, torsional shear values due to loads in the North/South direction were calculated looking at the entire building at each level. Torsional shear values due to wind loads were determined for both Wind Load Cases 1 and 2. Wind Load Case 1 just looks at the total wind load in one direction. Wind Load Case 2 uses (0.75)(wind load) but adds in an eccentricity of (0.15)(building width). Wind Load Case 1 was found to control over Wind Load Case 2. Torsional shear due to loads in the East/West direction were neglected since the center of mass and center of rigidity are located at the same point or within one foot of each other in that direction. Plus, the five truss frames in the East/West direction are evenly spaced 30’-0” apart and are centered on the center of the building in the East/West direction. Therefore, it was assumed that torsional shear values in this direction would be negligible. Torsional shear due to eccentricities from Wind Load Case 2 was also neglected and assumed not to control for the East/West direction. Calculations for torsional shear are found in Appendix B.

$$\text{Torsional Shear: } F_{it} = [(k_i)(d_i)(P_y)(e_x)] / [\sum((k_j)(d_j)^2)]$$

Due to Seismic Loads:

$$1.2D + 1.0E + L + 0.2S$$

Torsional Shear - North/South Direction - Level 1				
Load Combination = 1.2D+1.0E+L+0.2S	Force (k)	Factored Force (k)	Distributed Force (kips)	
			Braced Frame - Column Line 1 - Level 1	Moment Frame - Column Line 1.8 - Level 1
Level 1	112.92	112.92	3.00	15.00

Table 40 – Torsional Shear Values due to Seismic Loads for Level 1 (North/South)

Torsional Shear - North/South Direction - Level 2					
Load Combination = 1.2D+1.0E+L+0.2S	Force (k)	Factored Force (k)	Distributed Force (kips)		
			Braced Frame - Column Line 1 - Level 2	Braced Frame - Column Line 2 - Level 2	Moment Frame - Column Line 4 - Level 2
Level 2	154.34	154.34	3.42	13.41	3.68

Table 41 – Torsional Shear Values due to Seismic Loads for Level 2 (North/South)

Torsional Shear - North/South Direction - Level 3				
Load Combination = 1.2D+1.0E+L+0.2S	Force (k)	Factored Force (k)	Distributed Force (kips)	
			Braced Frame - Column Line 1 - Level 3	Braced Frame - Column Line 2 - Level 3
Level 3	15.21	15.21	0.18	0.91

Table 42 – Torsional Shear Values due to Seismic Loads for Level 3 (North/South)

Torsional Shear - North/South Direction - Level 4			
Load Combination = 1.2D+1.0E+L+0.2S	Force (k)	Factored Force (k)	Distributed Force (kips)
			Braced Frame - Column Line 1 - Level 4
Level 4	6.80	6.80	0.00

Table 43 – Torsional Shear Values due to Seismic Loads for Level 4 (North/South)

Due to Wind Loads:

$$1.2D + 1.6W + L + 0.5(Lr \text{ or } S \text{ or } R)$$

Load Case 1:

Torsional Shear - North/South Direction - Level 1				
Load Combination = 1.2D+1.6W+L+0.5(Lr or S or R)	Force (k)	Factored Force (k)	Distributed Force (kips)	
			Braced Frame - Column Line 1 - Level 1	Moment Frame - Column Line 1.8 - Level 1
Level 1	52.60	84.15	1.30	6.50

Table 44 – Torsional Shear Values due to Wind Load Case 1 for Level 1 (North/South)

Torsional Shear - North/South Direction - Level 2					
Load Combination = 1.2D+1.6W+L+0.5(Lr or S or R)	Force (k)	Factored Force (k)	Distributed Force (kips)		
			Braced Frame - Column Line 1 - Level 2	Braced Frame - Column Line 2 - Level 2	Moment Frame - Column Line 4 - Level 2
Level 2	56.76	90.82	0.93	3.65	1.00

Table 45 – Torsional Shear Values due to Wind Load Case 1 for Level 2 (North/South)

Torsional Shear - North/South Direction - Level 3				
Load Combination = 1.2D+1.6W+L+0.5(Lr or S or R)	Force (k)	Factored Force (k)	Distributed Force (kips)	
			Braced Frame - Column Line 1 - Level 3	Braced Frame - Column Line 2 - Level 3
Level 3	45.45	72.72	0.96	4.80

Table 46 – Torsional Shear Values due to Wind Load Case 1 for Level 3 (North/South)

Torsional Shear - North/South Direction - Level 4			
Load Combination = 1.2D+1.6W+L+0.5(Lr or S or R)	Force (k)	Factored Force (k)	Distributed Force (kips)
			Braced Frame - Column Line 1 - Level 4
Level 4	14.03	22.45	0.00

Table 47 – Torsional Shear Values due to Wind Load Case 1 for Level 4 (North/South)

Load Case 2:

Torsional Shear - North/South Direction - Level 1				
Load Combination = 1.2D+1.6W+L+0.5(Lr or S or R)	Force (k)	Factored Force (k)	Distributed Force (kips)	
			Braced Frame - Column Line 1 - Level 1	Moment Frame - Column Line 1.8 - Level 1
Level 1	39.45	63.12	2.42	12.08

Table 48 – Torsional Shear Values due to Wind Load Case 2 for Level 1 (North/South)

Torsional Shear - North/South Direction - Level 2					
Load Combination = 1.2D+1.6W+L+0.5(Lr or S or R)	Force (k)	Factored Force (k)	Distributed Force (kips)		
			Braced Frame - Column Line 1 - Level 2	Braced Frame - Column Line 2 - Level 2	Moment Frame - Column Line 4 - Level 2
Level 2	42.57	68.12	1.79	7.02	1.93

Table 49 – Torsional Shear Values due to Wind Load Case 2 for Level 2 (North/South)

Torsional Shear - North/South Direction - Level 3				
Load Combination = 1.2D+1.6W+L+0.5(Lr or S or R)	Force (k)	Factored Force (k)	Distributed Force (kips)	
			Braced Frame - Column Line 1 - Level 3	Braced Frame - Column Line 2 - Level 3
Level 3	34.09	54.54	1.49	7.47

Table 50 – Torsional Shear Values due to Wind Load Case 2 for Level 3 (North/South)

Torsional Shear - North/South Direction - Level 4			
Load Combination = 1.2D+1.6W+L+0.5(Lr or S or R)	Force (k)	Factored Force (k)	Distributed Force (kips)
			Braced Frame - Column Line 1 - Level 4
Level 4	10.52	16.84	0.00

Table 51 – Torsional Shear Values due to Wind Load Case 2 for Level 4 (North/South)

Total Shear

Total shear values were determined by combining the direct shear at each frame and level with the torsional shear at each frame and level. Torsional shear was either added or subtracted to the direct shear depending on which side of the center of rigidity the frames were located and which side of the center of rigidity the load was applied.

$$F_i = F_{i,direct} +/- F_{i,torsion}$$

Due to Seismic Loads:

North/South Direction:

Total Shear - North/South Direction - Braced Frame at Column Line 1			
Load Combination = 1.2D+1.0E+L+0.2S	Factored Direct Shear Force (k)	Factored Torsional Shear Force (k)	Total Factored Shear (k)
Level 1	2.61	(-) 0.00	6.80
Level 2	3.80	(-) 0.18	1.08
Level 3	1.26	3.42	0.38
Level 4	6.80	3.00	(-) 0.39

Table 52 – Total Shear Values due to Seismic Loads for Braced Frame at Column Line 1 (North South)

Total Shear - North/South Direction - Braced Frame at Column Line 2			
Load Combination = 1.2D+1.0E+L+0.2S	Factored Direct Shear Force (k)	Factored Torsional Shear Force (k)	Total Factored Shear (k)
Level 2	128.42	13.41	141.83
Level 3	8.90	0.91	9.82

Table 53 – Total Shear Values due to Seismic Loads for Braced Frame at Column Line 2 (North/South)

Total Shear - North/South Direction - Moment Frame at Column Line 1.8			
Load Combination = 1.2D+1.0E+L+0.2S	Factored Direct Shear Force (k)	Factored Torsional Shear Force (k)	Total Factored Shear (k)
Level 1	15.00	39.90	54.90

Table 54 – Total Shear Values due to Seismic Loads for Moment Frame at Column Line 1.8 (North/South)

Total Shear - North/South Direction - Moment Frame at Column Line 4			
Load Combination = 1.2D+1.0E+L+0.2S	Factored Direct Shear Force (k)	Factored Torsional Shear Force (k)	Total Factored Shear (k)
Level 2	6.92	3.68	10.60

Table 55 – Total Shear Values due to Seismic Loads for Moment Frame at Column Line 4 (North/South)

East/West Direction:

Total Shear - East/West Direction - Truss/Moment Frame			
Load Combination = 1.2D+1.0E+L+0.2S	Factored Direct Shear Force (k)	Factored Torsional Shear Force (k)	Total Factored Shear (k)
Level 1	2.61	0.00	2.61
Level 2	7.19	0.00	7.19
Level 3	3.04	0.00	3.04
Level 4	6.80	0.00	6.80

Table 56 – Total Shear Values due to Seismic Loads for Truss/Moment Frame (East/West)

Total Shear - East/West Direction - Truss/Moment Frame - Joint at Column Line 1.8			
Load Combination = 1.2D+1.0E+L+0.2S	Factored Direct Shear Force (k)	Factored Torsional Shear Force (k)	Total Factored Shear (k)
Level 1	14.14	0.00	14.14

Table 57 – Total Shear Values due to Seismic Loads for Truss/Moment Frame – Joint at Column Line 1.8 (East/West)

Total Shear - East/West Direction - Truss/Moment Frame - Joint at Column Line 2			
Load Combination = 1.2D+1.0E+L+0.2S	Factored Direct Shear Force (k)	Factored Torsional Shear Force (k)	Total Factored Shear (k)
Level 2	23.68	0.00	23.68

Table 58 – Total Shear Values due to Seismic Loads for Truss/Moment Frame – Joint at Column Line 2 (East/West)

Due to Wind Loads:

Load Case 1:

North/South Direction:

Total Shear - North/South Direction - Braced Frame at Column Line 1			
Load Combination = 1.2D+1.6W+L+0.5 (Lr or S or R)	Factored Direct Shear Force (k)	Factored Torsional Shear Force (k)	Total Factored Shear (k)
Level 1	12.90	0.00	4.49
Level 2	7.69	0.60	6.93
Level 3	5.97	(-) 0.93	6.76
Level 4	4.49	(-) 1.30	11.59

Table 59 – Total Shear Values due to Wind Load Case 1 for Braced Frame at Column Line 1 (North/South)

Total Shear - North/South Direction - Braced Frame at Column Line 2			
Load Combination = 1.2D+1.6W+L+0.5 (Lr or S or R)	Factored Direct Shear Force (k)	Factored Torsional Shear Force (k)	Total Factored Shear (k)
Level 2	56.85	3.65	60.49
Level 3	42.85	(-) 4.80	38.04

Table 60 – Total Shear Values due to Wind Load Case 1 for Braced Frame at Column Line 2 (North/South)

Total Shear - North/South Direction - Moment Frame at Column Line 4			
Load Combination = 1.2D+1.6W+L+0.5 (Lr or S or R)	Factored Direct Shear Force (k)	Factored Torsional Shear Force (k)	Total Factored Shear (k)
Level 2	5.87	1.00	6.87

Table 61 – Total Shear Values due to Wind Load Case 1 for Moment Frame at Column Line 4 (North/South)

East/West Direction:

Total Shear - East/West Direction - Truss/Moment Frame			
Load Combination = 1.2D+1.6W+L+0.5 (Lr or S or R)	Factored Direct Shear Force (k)	Factored Torsional Shear Force (k)	Total Factored Shear (k)
Level 1	16.27	0.00	16.27
Level 2	17.08	0.00	17.08
Level 3	17.94	0.00	17.94
Level 4	9.79	0.00	9.79

Table 62 – Total Shear Values due to Wind Load Case 1 for Truss/Moment Frame (East/West)

Load Case 2:

North/South Direction:

Total Shear - North/South Direction - Braced Frame at Column Line 1			
Load Combination = 1.2D+1.6W+L+0.5 (Lr or S or R)	Factored Direct Shear Force (k)	Factored Torsional Shear Force (k)	Total Factored Shear (k)
Level 1	9.67	(-) 2.42	7.26
Level 2	5.77	(-) 1.79	3.98
Level 3	4.48	1.49	5.97
Level 4	3.37	0.00	3.37

Table 63 – Total Shear Values due to Wind Load Case 2 for Braced Frame at Column Line 1 (North/South)

Total Shear - North/South Direction - Braced Frame at Column Line 2			
Load Combination = 1.2D+1.6W+L+0.5 (Lr or S or R)	Factored Direct Shear Force (k)	Factored Torsional Shear Force (k)	Total Factored Shear (k)
Level 2	42.63	7.02	49.66
Level 3	32.13	(-) 7.47	24.66

Table 64 – Total Shear Values due to Wind Load Case 2 for Braced Frame at Column Line 2 (North/South)

Total Shear - North/South Direction - Moment Frame at Column Line 4			
Load Combination = 1.2D+1.6W+L+0.5 (Lr or S or R)	Factored Direct Shear Force (k)	Factored Torsional Shear Force (k)	Total Factored Shear (k)
Level 2	4.40	1.93	6.33

Table 65 – Total Shear Values due to Wind Load Case 2 for Moment Frame at Column Line 4 (North/South)

Drift and Displacement

Drift and displacement values were determined for each frame at each applicable level by applying the total forces due to direct loads and torsional loads to the SAP models of each frame. Drift values of the shear walls were not considered and were assumed to not be a concern since the shear walls were much stiffer than the steel frames. Plus, the shear walls only resisted seismic load caused by the precast concrete hollow core floor planks. The final loads applied to the shear walls was not much compared to the loads applied to the other steel frames, especially when taking into consideration the extremely high stiffness of the shear walls. Drifts due to seismic load were multiplied by a C_d factor of 3 and divided by an importance factor of 1.25. This value was then compared to $0.015h_{sx}$ for each story. All frames met the seismic load drift limits.

For drift due to seismic loads:

$$\Delta_x = (C_d)(\Delta_{xe})/I$$

$C_d = 3$ (Steel systems not specifically detailed for seismic resistance, excluding cantilever column systems)

$$I = 1.25$$

Table 12.12.1 (ASCE 7-05):

Allowable Story Drift = $0.015h_{sx}$ (all other structures, Occupancy Category III)

Drifts due to unfactored wind loads were compared to an allowable limit of $L/400$, with L being the elevation height of the level, or with L being the story height. Only one frame did not meet the unfactored wind load drift limits. This was the moment frame of the truss/moment frame system in the East/West direction. This moment frame consists of bent and sloped W27 beams that support the concrete grandstand. The lower ends of these sloped beams have moment connections where they frame into the supporting HSS columns. The fact that the drift due to wind at this point does not meet deflection criteria may be due to the way the frame was modeled in SAP, or the way the loads were applied to the frame. Plus, only the frame itself was modeled in SAP, whereas in reality there is a concrete grandstand sitting on this frame, and the precast concrete hollow core planks frame into the beams that are connected to this frame and run in the North/South direction. The grandstand and precast concrete hollow core planks may actually help resist this deflection, whereas any effects from the grandstand and hollow core planks, or any other members framing into this frame, were not considered in this analysis.

North/South Direction:

Deflections - North/South Direction - Braced Frame at Column Line 1					
Unfactored Seismic	Deflection from SAP (in)	Defl. _x = (C _d *Defl. _{xe})/I	Elevation (ft)	Limit = 0.015h _{sx} (in)	
Level 1	0.1704	0.4089	10.50	1.8900	OK
Level 2	0.4561	1.0947	24.67	4.4400	OK
Level 3	0.7512	1.8030	37.67	6.7800	OK
Level 4	1.1491	2.7577	53.00	9.5400	OK

Table 66 – Deflections due to Seismic Load for Braced Frame at Column Line 1 (North/South)

Story Drifts - North/South Direction - Braced Frame at Column Line 1					
Unfactored Seismic	Deflection (in)	Defl. _x = (C _d *Defl. _{xe})/I	Story Height (ft)	Limit = 0.015h _{sx} (in)	
Level 1	0.1704	0.4089	10.50	1.8900	OK
Level 2	0.2858	0.6858	14.17	2.5500	OK
Level 3	0.2951	0.7083	13.00	2.3400	OK
Level 4	0.3978	0.9547	15.33	2.7600	OK

Table 67 – Story drifts due to Seismic Load for Braced Frame at Column Line 1 (North/South)

Deflections - North/South Direction - Braced Frame at Column Line 1				
Unfactored Wind	Deflection from SAP (in)	Elevation (ft)	Limit =L/400 (in)	
Level 1	0.2777	10.50	0.3150	OK
Level 2	0.6049	24.67	0.7400	OK
Level 3	0.8891	37.67	1.1300	OK
Level 4	1.2276	53.00	1.5900	OK

Table 68 – Deflections due to Wind Loads for Braced Frame at Column Line 1 (North/South)

Story Drifts - North/South Direction - Braced Frame at Column Line 1				
Unfactored Wind	Deflection (in)	Story Height (ft)	Limit =L/400 (in)	
Level 1	0.2777	10.50	0.3150	OK
Level 2	0.3272	14.17	0.4250	OK
Level 3	0.2841	13.00	0.3900	OK
Level 4	0.3385	15.33	0.4600	OK

Table 69 – Story Drifts due to Wind Loads for Braced Frame at Column Line 1 (North/South)

Deflections - North/South Direction - Braced Frame at Column Line 2					
Unfactored Seismic	Deflection from SAP (in)	Defl. _x = (C _d *Defl. _{xe})/I	Elevation (ft)	Limit = 0.015h _{sx} (in)	
Level 2	1.1662	2.7988	24.67	4.4400	OK
Level 3	1.3212	3.1709	37.67	6.7800	OK

Table 70 – Deflections due to Seismic Loads for Braced Frame at Column Line 2 (North/South)

Story Drifts - North/South Direction - Braced Frame at Column Line 2					
Unfactored Seismic	Deflection from SAP (in)	Defl. _x = (C _d *Defl. _{xe})/I	Story Height (ft)	Limit = 0.015h _{sx} (in)	
Level 2	1.1662	2.7988	24.67	4.4400	OK
Level 3	0.1550	0.3721	13.00	2.3400	OK

Table 71 – Story Drifts due to Seismic Loads for Braced Frame at Column Line 2 (North/South)

Deflections - North/South Direction - Braced Frame at Column Line 2				
Unfactored Wind	Deflection from SAP (in)	Elevation (ft)	Limit =L/400 (in)	
Level 2	0.4934	24.67	0.7400	OK
Level 3	0.5628	37.67	1.1300	OK

Table 72 – Deflections due to Wind Loads for Braced Frame at Column Line 2 (North/South)

Story Drifts - North/South Direction - Braced Frame at Column Line 2				
Unfactored Wind	Deflection from SAP (in)	Elevation (ft)	Limit =L/400 (in)	
Level 2	0.4934	24.67	0.7400	OK
Level 3	0.0694	13.00	0.3900	OK

Table 73 – Story Drifts due to Wind Loads for Braced Frame at Column Line 2 (North/South)

Deflections - North/South Direction - Moment Frame at Column Line 1.8					
Unfactored Seismic	Deflection from SAP (in)	Defl. _x = (C _d *Defl. _{xe})/I	Elevation (ft)	Limit = 0.015h _{sx} (in)	
Level 1	0.0780	0.1873	10.50	1.8900	OK

Table 74 – Deflections due to Seismic Loads for Moment Frame at Column Line 1.8 (North/South)

Story Drifts - North/South Direction - Moment Frame at Column Line 1.8					
Unfactored Seismic	Deflection from SAP (in)	Defl. _x = (C _d *Defl. _{xe})/I	Elevation (ft)	Limit = 0.015h _{sx} (in)	
Level 1	0.0780	0.1873	10.50	1.8900	OK

Table 75 – Story Drifts due to Seismic Loads for Moment Frame at Column Line 1.8 (North/South)

Deflections - North/South Direction - Moment Frame at Column Line 4					
Unfactored Seismic	Deflection from SAP (in)	Defl. _x = (C _d *Defl. _{xe})/I	Elevation (ft)	Limit = 0.015h _{sx} (in)	
Level 1	0.4958	1.1900	24.67	4.4400	OK

Table 76 – Deflections due to Seismic Loads for Moment Frame at Column Line 4 (North/South)

Story Drifts - North/South Direction - Moment Frame at Column Line 4					
Unfactored Seismic	Deflection from SAP (in)	Defl. _x = (C _d *Defl. _{xe})/I	Elevation (ft)	Limit = 0.015h _{sx} (in)	
Level 1	0.4958	1.1900	24.67	4.4400	OK

Table 77 – Story Drifts due to Seismic Loads for Moment Frame at Column Line 4 (North/South)

Deflections - North/South Direction - Moment Frame at Column Line 4				
Unfactored Wind	Deflection from SAP (in)	Elevation (ft)	Limit = L/400 (in)	
Level 1	0.2008	24.67	0.7400	OK

Table 78 – Deflections due to Wind Loads for Moment Frame at Column Line 4 (North/South)

Story Drifts - North/South Direction - Moment Frame at Column Line 4				
Unfactored Wind	Deflection from SAP (in)	Elevation (ft)	Limit = L/400 (in)	
Level 1	0.2008	24.67	0.7400	OK

Table 79 – Story Drifts due to Wind Loads for Moment Frame at Column Line 4 (North/South)

East/West Direction:

Deflections - East/West Direction - Truss/Moment Frame					
Unfactored Seismic	Deflection from SAP (in)	Defl. _x = (C _d *Defl. _{xe})/I	Elevation (ft)	Limit = 0.015h _{sx} (in)	
Level 1	0.4171	1.0010	10.50	1.8900	OK
Level 2	0.4316	1.0358	24.67	4.4400	OK
Level 3	0.5291	1.2700	37.67	6.7800	OK
Level 4	0.5107	1.2258	53.00	9.5400	OK

Table 80 – Deflections due to Seismic Loads for Truss/Moment Frame (East/West)

Story Drifts - East/West Direction - Truss/Moment Frame					
Unfactored Seismic	Deflection (in)	Defl. _x = (C _d *Defl. _{xe})/I	Story Height (ft)	Limit = 0.015h _{sx} (in)	
Level 1	0.1704	0.4089	10.50	1.8900	OK
Level 2	0.0145	0.0349	14.17	2.5500	OK
Level 3	0.0976	0.2341	13.00	2.3400	OK
Level 4	-0.0184	-0.0442	15.33	2.7600	OK

Table 81 – Story Drifts due to Seismic Loads for Truss/Moment Frame (East/West)

Deflections - East/West Direction - Truss/Moment Frame				
Unfactored Wind	Deflection from SAP (in)	Elevation (ft)	Limit =L/400 (in)	
Level 1	0.4988	10.50	0.3150	NOT OK
Level 2	0.5155	24.67	0.7400	OK
Level 3	0.7047	37.67	1.1300	OK
Level 4	0.6882	53.00	1.5900	OK

Table 82 – Deflections due to Wind Loads for Truss/Moment Frame (East/West)

Story Drifts - East/West Direction - Truss/Moment Frame				
Unfactored Wind	Deflection (in)	Story Height (ft)	Limit =L/400 (in)	
Level 1	0.4988	10.50	0.3150	NOT OK
Level 2	0.0167	14.17	0.4250	OK
Level 3	0.1892	13.00	0.3900	OK
Level 4	-0.0164	15.33	0.4600	OK

Table 83 – Story Drifts due to Wind Loads for Truss/Moment Frame (East/West)

Overturning

The lateral forces applied to the building cause overturning moments at the bases of the lateral force resisting frames. The dead weight of the building resists these upward forces caused by the overturning moments. The worst case of overturning moments occurred at the braced frames in the North/South directions at column line 1. A more detailed check of overturning effects at this location was performed and is shown below.

Braced frames at column line 1 (North/South direction):

Look at load combination $0.9D + 1.6W$

Tributary area for each frame = $(30')(130'/2) = 1950$ SF

Net wind uplift = 10 PSF

Upward/overturning force due to $1.6W = 137.37$ k (from SAP model)

Upward/overturning force due to net wind uplift = $(1.6)(10 \text{ PSF})(1950 \text{ SF})/1000 = 31.2$ k

Total upward force at base = $137.37 \text{ k} + 31.2 \text{ k} = 168.57$ k

Resistance is provided by dead load of concrete footing and concrete pier

Footing: $[(19')(19')(2')](150 \text{ PCF})/1000 = 108.3$ k

Pier: $[(9.667')(8.333')(10')](150 \text{ PCF})/1000 = 106.3$

Total Resistance due to dead load = $(0.9)(108.3 \text{ k} + 106.3 \text{ k}) = 193.1667$ k

$193.1667 \text{ k} > 168.67 \text{ k}$ therefore OK

The dead weight of the large concrete footings and piers at this location was able to resist the upward forces caused by the overturning moments. Also, the net uplift service load value of 10 psf was slightly high due to conservative assumptions that were made with the C_p values for roof wind forces. Although the net uplift value prevent the dead weight of the roof above the large trusses from resisting the overturning moment forces, the footing and piers themselves were able to resist all of the loads. Therefore, it appears that overturning moments should not be much of a concern with this building. The upward forces due to overturning moments at the bases of most of the other lateral force resisting frames was less than 5 or 10 kips. These values are rather low, especially when compared to the high dead loads of the other parts of the building that will provide more than enough resistance to prevent overturning moments from becoming a problem.

Spot Checks

Column of Moment Frame at Column Line 4

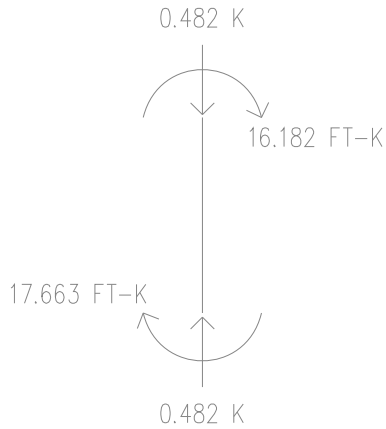

Figure ___ - P_{lt} , M_{lt}

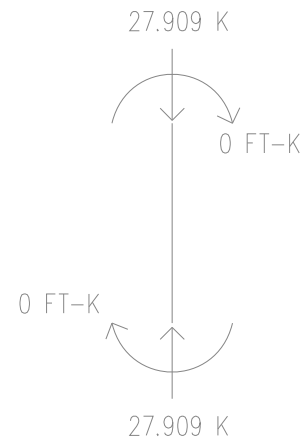

Figure ___ - P_{nt} , M_{nt}

Member: HSS10x10x3/8

Tributary Area to HSS10x10x3/8 = $(42'/2)(15') = 315$ SF

Loads:

$$D = (70.5 \text{ PSF})(315 \text{ SF})/1000 = 22.208 \text{ k}$$

$$L_r = 20 \text{ PSF}$$

$$S = (23.1 \text{ PSF})(315 \text{ SF})/1000 = 7.277 \text{ k}$$

Controlling Load Combination: $1.2D + 1.0E + 0.5L + 0.2S$

Axial Loads:

$$1.2D = (1.2)(22.208 \text{ k}) = 26.649 \text{ k}$$

$$1.0E = (1.0)(0.482 \text{ k}) = 0.482 \text{ k}$$

$$0.2S = (0.2)(7.277 \text{ k}) = 1.260 \text{ k}$$

Moments:

$$1.0E = (1.0)(17.663 \text{ ft-k}) = 17.663 \text{ ft-kip}$$

$$M_{nt} = 0 \text{ ft-k}$$

$$M_{lt} = 17.663 \text{ ft-k}$$

$$P_{nt} = 27.909 \text{ k}$$

$$P_{lt} = 0.482 \text{ k}$$

$$P_r = P_{nt} + B_2P_{lt}$$

$$M_r = B_1M_{nt} + B_2M_{lt}$$

$$B_2 = 1/[1 - (\alpha \sum P_{nt}/\sum P_{e2})]$$

$$\alpha = 1.0$$

$$\sum P_{nt} = (1.2)(461.916 \text{ k}) + (0.2)(20 \text{ PSF})(42' \times 156')/1000 = 580.507 \text{ k}$$

$$\sum P_{e2} = R_m[\sum HL/\Delta H] = (0.85)[(10.605 \text{ k})(24')(12 \text{ in/ft})/1.1900 \text{ in}] = 2181.526 \text{ k}$$

$$R_m = 0.85$$

$$H = 10.605 \text{ k}$$

$$L = 24'$$

$$\Delta H = 1.1900 \text{ in.}$$

$$B_2 = 1/[1 - ((1.0)(580.507 \text{ k})/2181.526 \text{ k})] = 1.363$$

$$P_r = P_{nt} + B_2P_{lt} = 27.909 \text{ k} + (1.363)(0.432 \text{ k}) = 28.498 \text{ k}$$

$$M_r = B_1M_{nt} + B_2M_{lt} = 0 \text{ ft-k} + (1.363)(17.663 \text{ ft-k}) = 24.067 \text{ ft-k}$$

$$\text{HSS } 10 \times 10 \times 5/8 \text{ with } KL = 24': \Phi P_n = 252 \text{ ft-k}$$

$$P_r/\Phi P_n = 28.498 \text{ k} / 252 \text{ k} = 0.113 \leq 0.2 \text{ therefore use Eqn. H1-1b}$$

$$\frac{1}{2} pP_r + (9/8)(b_x M_{rx} + b_y M_{ry}) \leq 1.0$$

$$p = 1/\Phi P_n = 1/252 \text{ k} = 0.001689$$

$$b_x = 8/9\Phi M_n = 8/[(9)(252 \text{ k})] = 0.003527$$

$$(1/2)(0.001689)(28.498 \text{ k}) + (9/8)(0.003527)(24.0674 \text{ ft-k}) = 0.01196 \leq 1.0 \text{ therefore OK}$$

*Note: Neglecting any moments due to gravity loads, but it appears that this member should be OK if they were included since the member's capacity is much higher than that required

Brace of Braced Frame at Column Line 1

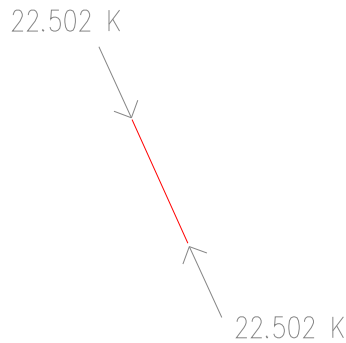

*Neglecting gravity loads in this member – further analysis will be required in the future

Member: HSS3.500x0.216

Axial force due to 1.6W = 22.502 k (controls over 1.0E)

$$L = 14.547'$$

$$A = 2.08 \text{ in}^2$$

$$R = 1.17 \text{ in.}$$

K = 1.0 (member is pinned at both ends)

$$KL/r = (1.0)[(14.547')(12 \text{ in/ft})]/1.17 = 149.199$$

$$KL/r = 149.199 > 4.71\sqrt{E/F_y} = 4.71\sqrt{(29000 \text{ ksi}/50 \text{ ksi})} = 113.432$$

$$F_{cr} = 0.877F_e$$

$$F_e = (\pi)^2(E)/(KL/r)^2 = (\pi)^2(29000 \text{ ksi})/(149.199)^2 = 12.858 \text{ ksi}$$

$$F_{cr} = (0.877)(12.858 \text{ ksi}) = 11.276 \text{ ksi}$$

$$P_n = (11.276 \text{ ksi})(2.08 \text{ in}^2) = 23.455 \text{ k} \geq 22.502 \text{ k} \text{ therefore OK}$$

Brace of Braced Frame at Column Line 2

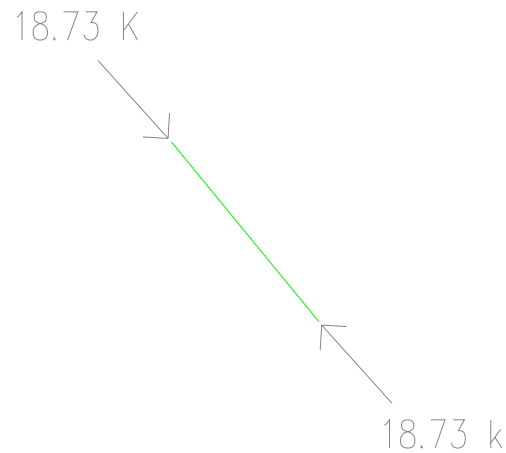

*Neglecting gravity loads in this member – further analysis will be required in the future

Member: HSS4.500x0.237

Axial force due to 1.0E = 18.73 k (1.6W caused an axial load of only 13.87 k)

L = 19'

A = 2.96 in²

R = 1.52 in.

K = 1.0 (member is pinned at both ends)

$KL/r = (1.0)[(19')(12 \text{ in/ft})]/1.52 = 150$

$KL/r = 150 > 4.71\sqrt{E/F_y} = 4.71\sqrt{(29000 \text{ ksi}/50 \text{ ksi})} = 113.432$

$F_{cr} = 0.877F_e$

$F_e = (\pi)^2(E)/(KL/r)^2 = (\pi)^2(29000 \text{ ksi})/(150)^2 = 12.721 \text{ ksi}$

$F_{cr} = (0.877)(12.721 \text{ ksi}) = 11.156 \text{ ksi}$

$P_n = (11.156 \text{ ksi})(2.96 \text{ in}^2) = 33.022 \text{ k} \geq 18.73 \text{ k}$ therefore OK

Conclusion

After revising the wind and seismic loads determined in Technical Report 1, the lateral loads were applied to the braced frames, moment frames, and concrete shear walls. After applying the appropriate load combinations set forth by ASCE 7-05, it was determined that wind loads generally controlled the indoor pool area with the large trusses due to the fact that this area was basically open space with a large amount of surface area of exterior wall, which created high wind loads. Seismic loads generally controlled the frames connected to the precast concrete hollow core floor planks, balcony, and grandstand seating due to the excessive weight of this area and the fact that little wind load is applied in this area.

All calculations for this assignment were done by hand. SAP2000 was only used to determine drifts and story drifts after applying the appropriate calculated loads. Most results appear to match the existing results, and any differences could be due to the way the forces were distributed to each frame and the way the building was broken up into four vertical levels. After speaking with Nutec, the only real area of concern in the original design was the connection at a joint of the trusses where the trusses bend. This joint has several members framing into it from many different directions, and connecting all of these members together was considered to be an issue.

After performing a lateral load analysis on each lateral force resisting frame, it was determined that the frames were adequately designed to resist the applied lateral loads. Torsion due to the eccentricity between the center of mass and center of rigidity was taken into consideration, and torsional loads were applied to each frame along with the direct loads. Almost all of the steel frames met the drift and story drift limitations set forth by ASCE 7-05. The deflections of the shear walls were not taken into consideration due to the fact that the main lateral force resisting system for the building is composed of steel frames. Plus, the shear walls are extremely stiff compared to the steel frames since the walls are only about 10' tall, and the loads applied to the shear walls are not very high anyway. Accidental torsion, or load case two, was not applied to the wind load analysis for the East/West direction since the five truss frames are evenly spaced and centered on the building. It was assumed that torsion would not be much of an issue due to the layout of the lateral force resisting frames in this direction. Spot checks performed on a moment frame column and two braces from braced frames confirmed that these members were adequately designed. Also, a check on the effects of overturning moments on foundations showed that the dead weight of the footings and structure provides more than enough resistance against the upward forces produced by the overturning moments.

Appendix A – Center of Mass Calculations

North/South Direction

“Building 1” – Level 1

Building 1 - Level 1			
Weights of Building Components		Center of Mass	
Component	Weight	x (ft)	y (ft)
Large Truss Columns	9.270 kips	5.8126	78.0000
Wind Columns	7.785 kips	51.9010	78.0000
Precast Concrete Panels	484.223 kips	31.5959	80.8546
Total=	501.277 kips	31.4344	80.7575

Columns Supporting Large Trusses								Center of Mass	
Size	Length (ft)	Weight/ft	Quantity	Weight (lb)	% of Weight Applied to Level 1	Weight at Level 1 (lb)		x (ft)	y (ft)
HSS8x8x5/16	11.260	31.79	2	715.94	0.5	0.36		2.01563	
	13.302	31.79	2	845.75	0.5	0.42		2.60937	
HSS12.75x0.375	13.839	49.61	1	686.53	0.5	0.34		8.1510	
	13.839	49.61	1	686.53	0.5	0.34		10.1510	
HSS4.500x0.237	14.620	10.8	2	315.79	0.5	0.16		7.01563	
HSS3.500x0.216	6.828	7.58	2	103.51	1	0.10		5.73437	
HSS3.500x0.250	14.411	8.69	2	250.47	0.5	0.13		7.72917	
Total (for one truss)=						1.85	kips	5.81263	78.0000
x5 (for all 5 trusses)=						9.2701	kips		

Wind Column Trusses						
	Size	Length (ft)	lb/ft	Quantity	Weight (kips)	
1	HSS8x8x5/16	12.333	31.79	1	0.392	
	HSS7.500x0.312	11.083	23.97	1	0.266	
	HSS3.500x0.216	13.547	7.58	1	0.103	
	HSS2.500x0.250	3.000	6.01	1	0.018	
2	HSS8x8x5/16	12.333	31.79	1	0.392	
	HSS7.500x0.312	11.083	23.97	1	0.266	
	HSS3.500x0.216	13.547	7.58	1	0.103	
	HSS2.500x0.250	3.000	6.01	1	0.018	
3	HSS8x8x5/16	12.333	31.79	1	0.392	
	HSS7.500x0.312	11.083	23.97	1	0.266	
	HSS3.500x0.216	13.547	7.58	1	0.103	
	HSS2.500x0.250	3.000	6.01	1	0.018	
4	HSS8x8x5/16	12.333	31.79	1	0.392	
	HSS7.500x0.312	11.083	23.97	1	0.266	
	HSS3.500x0.216	13.547	7.58	1	0.103	
	HSS2.500x0.250	3.000	6.01	1	0.018	
5	HSS8x8x5/16	12.333	31.79	1	0.392	
	HSS7.500x0.312	11.083	23.97	1	0.266	
	HSS3.500x0.216	13.547	7.58	1	0.103	
	HSS2.500x0.250	3.000	6.01	1	0.018	
TOTAL=					3.892	kips
x 2=					7.785	kips

Precast Concrete Panels					Center of Mass	
	Area (SF)	psf	Weight (kips)		x (in)	y (in)
North Precast Elevation	1544.4931	100	154.44931	1544.4931	722.1789	1868
South Precast Elevation	1366.5207	100	136.65207	1366.5207	675.9307	4
West Precast Elevation	1931.2127	100	193.12127		(-)105.1875	936
		Total=	484.22265 kips		379.1508	970.2550

“Building 1” – Level 2

Building 1 - Level 2			
Weights of Building Components		Center of Mass	
Component	Weight	x (ft)	y (ft)
Large Truss Columns	9.362 kips	7.4825	78.0000
Wind Columns	9.078 kips	51.9010	78.0000
Precast Concrete Panels	458.031 kips	30.0784	81.5370
Precast Concrete Sills	112.577 kips	60.4948	78.0000
Total=	589.048 kips	35.8686	81.4001

Columns Supporting Large Trusses							Center of Mass	
Size	Length (ft)	Weight/ft	Quantity	Weight (lb)	Weight at Level 2 (lb)		x (ft)	y (ft)
HSS8x8x5/16	6.656	31.79	2	423.20	0.423		3.20833	
	5.630	31.79	2	357.97	0.358		3.71875	
HSS12.75x0.375	6.922	49.61	1	343.39	0.343		12.1510	
	5.859	49.61	1	290.68	0.291		13.9896	
HSS4.500x0.237	8.599	10.8	2	185.74	0.186		6.74479	
HSS6.000x0.280	9.656	7.58	2	146.39	0.146		8.31250	
HSS3.500x0.250	7.198	8.69	2	125.10	0.125		4.90104	
				Total (for one truss)=	1.87	kips	7.48252	78.0000
				x5 (for all 5 trusses)=	9.3624	kips		

Wind Column Trusses					
	Size	Length (ft)	lb/ft	Quantity	Weight (kips)
1	HSS8x8x5/16	13.583	31.79	1	0.432
	HSS7.500x0.312	13.583	23.97	1	0.326
	HSS3.500x0.216	15.083	7.58	1	0.114
	HSS2.500x0.250	3.000	6.01	2	0.036
2	HSS8x8x5/16	13.583	31.79	1	0.432
	HSS7.500x0.312	13.583	23.97	1	0.326
	HSS3.500x0.216	15.083	7.58	1	0.114
	HSS2.500x0.250	3.000	6.01	2	0.036
3	HSS8x8x5/16	13.583	31.79	1	0.432
	HSS7.500x0.312	13.583	23.97	1	0.326
	HSS3.500x0.216	15.083	7.58	1	0.114
	HSS2.500x0.250	3.000	6.01	2	0.036
4	HSS8x8x5/16	13.583	31.79	1	0.432
	HSS7.500x0.312	13.583	23.97	1	0.326
	HSS3.500x0.216	15.083	7.58	1	0.114
	HSS2.500x0.250	3.000	6.01	2	0.036
5	HSS8x8x5/16	13.583	31.79	1	0.432
	HSS7.500x0.312	13.583	23.97	1	0.326
	HSS3.500x0.216	15.083	7.58	1	0.114
	HSS2.500x0.250	3.000	6.01	2	0.036
TOTAL=					4.539 kips
x 2=					9.078 kips

Precast Concrete Panels				Center of Mass	
	Area (SF)	psf	Weight (kips)	x (in)	y (in)
North Precast Elevation	1428.8437	100	142.88437	726.0000	1868
South Precast Elevation	1220.253	100	122.0253	671.1875	4
West Precast Elevation	1931.2127	100	193.12127	(-)105.1875	936
Total=			458.03094 kips	360.9406	978.4440
				30.0784	81.5370

Total (in.)
Total (ft.)

“Building 1” – Level 3

Building 1 - Level 3			
Weights of Building Components		Center of Mass	
Component	Weight	x (ft)	y (ft)
Large Truss Columns	5.085 kips	9.1255	78.0000
Large Trusses	68.768 kips	76.4985	78.0000
Wind Columns	9.353 kips	51.9010	78.0000
Roofing	79.913 kips	110.6510	78.0000
Additional Framing	22.391	108.8412	78.0000
Total=	163.119 kips	92.0275	78.0000

Columns Supporting Large Trusses						Center of Mass	
Size	Length (ft)	Weight/ft	Quantity	Weight (lb)	Weight at Level 3 (lb)	x (ft)	y (ft)
HSS8x8x5/16	5.630	31.79	2	357.97	0.358	3.06771	
HSS3.500x0.216	12.057	7.58	2	182.79	0.183	9.34896	
HSS12.75x0.375	5.854	49.61	1	290.43	0.290	14.5365	
HSS4.500x0.237	8.599	10.8	2	185.74	0.186	12.11979	
Total (for one truss)=					1.02	kip	
x5 (for all 5 trusses)=					5.0846	kip	78.0000

Large Trusses Over Pool					Center of Mass		
Size	Length (ft)	Weight/ft	Quantity	Weight (at Level 3)	x (ft)	y (ft)	
HSS6.625X0.280	9.828	18.99	2	373.27	13.4427		
HSS6.625X0.280	7.984	18.99	2	303.25	17.6771		
HSS6.625X0.280	9.781	18.99	2	371.49	28.7344		
HSS3.500x0.250	7.453	8.69	2	129.54	31.9010		
HSS3.500x0.250	7.516	8.69	2	130.62	51.9010		
HSS3.500x0.250	7.464	8.69	2	129.72	111.9010		
HSS6.625X0.280	9.521	18.99	2	361.60	34.8646		
HSS6.625X0.280	9.578	18.99	2	363.78	48.9271		
HSS6.625X0.280	10.099	18.99	2	383.56	55.2708		
HSS6.625X0.280	13.682	18.99	2	519.65	106.9010		
HSS6.625X0.280	11.354	18.99	2	431.23	116.9010		
HSS6.625X0.280	11.224	18.99	2	426.29	126.1094		
HSS3.500x0.250	10.708	8.69	2	186.11	68.4427		
HSS3.500x0.250	8.177	8.69	2	142.12	71.9010		
HSS3.500x0.250	11.870	8.69	2	206.30	76.2031		
HSS3.500x0.250	12.833	8.69	2	223.04	87.5208		
HSS3.500x0.250	9.250	8.69	2	160.77	91.9010		
HSS3.500x0.250	12.552	8.69	2	218.16	96.9010		
HSS8x8x5/16	7.672	31.79	2	487.78	4.8073		
	0.927	31.79	2	58.94	91.4479		
	10.135	31.79	2	644.41	96.9010		
	10.177	31.79	2	647.06	106.9010		
	10.214	31.79	2	649.38	116.9010		
	8.635	31.79	2	549.04	126.1094		
HSS12.750x0.375	15.375	49.61	1	762.75	24.2135		
	20.000	49.61	1	992.20	41.9010		
	20.000	49.61	1	992.20	61.9010		
	20.036	49.61	1	994.01	81.9010		
	20.078	49.61	1	996.08	101.9010		
	18.531	49.61	1	919.34	121.1094		
Total (for one truss)=				13753.66	lbs	76.4985	78.0000
Total (for one truss)=				13.75	kip		
x5 (for all 5 trusses)=				68.77	kip		

Wind Column Trusses						
	Size	Length (ft)	lb/ft	Quantity	Weight (kips)	
1	HSS8x8x5/16	14.167	31.79	1	0.450	
	HSS7.500x0.312	14.167	23.97	1	0.340	
	HSS3.500x0.216	15.734	7.58	1	0.119	
	HSS2.500x0.250	3.000	6.01	3	0.054	
2	HSS8x8x5/16	14.167	31.79	1	0.450	
	HSS7.500x0.312	14.167	23.97	1	0.340	
	HSS3.500x0.216	15.734	7.58	1	0.119	
	HSS2.500x0.250	3.000	6.01	3	0.054	
3	HSS8x8x5/16	14.167	31.79	1	0.450	
	HSS7.500x0.312	14.167	23.97	1	0.340	
	HSS3.500x0.216	15.734	7.58	1	0.119	
	HSS2.500x0.250	3.000	6.01	3	0.054	
4	HSS8x8x5/16	14.167	31.79	1	0.450	
	HSS7.500x0.312	14.167	23.97	1	0.340	
	HSS3.500x0.216	15.734	7.58	1	0.119	
	HSS2.500x0.250	3.000	6.01	3	0.054	
5	HSS8x8x5/16	14.083	31.79	1	0.448	
	HSS7.500x0.312	9.224	23.97	1	0.221	
	HSS3.500x0.216	15.641	7.58	1	0.119	
	HSS2.500x0.250	3.000	6.01	2	0.036	
TOTAL=					4.677	kips
x 2=					9.353	kips

Additional Framing						Center of Mass		
	Size	Length (ft)	lb/ft	Quantity	Weight (kips)	x (ft)	y (ft)	
	HSS8x8x5/16	10.250	31.79	2	0.652	91.9010	78.0000	
	HSS4x4x1/4	10.250	12.18	2	0.250	111.9010	78.0000	
	HSS8x6x1/4	24.000	22.39	4	2.149	111.9010	78.0000	
	HSS8x8x5/16	24.000	31.79	4	3.052	91.9010	78.0000	
	HSS8x8x5/16	10.750	31.79	2	0.683	130.3177	78.0000	
	HSS8x8x5/16	24.000	31.79	4	3.052	130.3177	78.0000	
	HSS6x6x1/4	20.000	18.99	4	1.519	101.4010	78.0000	
	HSS6x6x1/4	18.417	18.99	4	1.399	120.6094	78.0000	
	HSS8x8x5/16	20.000	31.79	2	1.272	101.4010	78.0000	
	HSS8x8x5/16	18.417	31.79	2	1.171	120.6094	78.0000	
	HSS8x6x1/2	20.000	41.91	2	1.676	101.4010	78.0000	
	HSS8x6x1/2	18.417	41.91	2	1.544	120.6094	78.0000	
	HSS6.250x0.250	147.495	17.04	1	2.513	91.9010	78.0000	
	HSS6.625x0.280	20.000	18.99	2	0.760	101.4010	78.0000	
	HSS6.625x0.280	18.417	18.99	2	0.699	120.6094	78.0000	
TOTAL=					22.391	kips	108.8412	78.0000

“Building 1” – Level 4

Building 1 - Level 4			
Weights of Building Components		Center of Mass	
Component	Weight	x (ft)	y (ft)
Large Trusses	38.373 kips	42.1629	78.0000
Wind Columns	1.760 kips	37.2172	78.0000
Roofing	173.370 kips	48.3229	78.0000
Additional Framing	45.595 kips	41.0660	78.0000
Total=	259.097 kips	46.0581	78.0000

Large Trusses Over Pool						Center of Mass	
Size	Length (ft)	Weight/ft	Quantity	Weight (at Level 3)		x (ft)	y (ft)
HSS6.625X0.280	7.474	18.99	2	283.86		6.8542	
HSS6.625X0.280	6.109	18.99	2	232.03		18.5625	
HSS6.625X0.280	7.677	18.99	2	291.58		21.9271	
HSS3.500x0.250	5.583	8.69	2	97.04		30.7500	
HSS3.500x0.250	4.484	8.69	2	77.94		50.7500	
HSS6.625X0.280	6.557	18.99	2	249.05		38.7083	
HSS6.625X0.280	6.552	18.99	2	248.85		42.7813	
HSS6.625X0.280	4.885	18.99	2	185.55		59.1198	
HSS3.500x0.250	4.766	8.69	2	82.83		62.2917	
HSS3.500x0.250	2.583	8.69	2	44.90		70.7500	
HSS3.500x0.250	1.927	8.69	2	33.49		80.0521	
HSS3.500x0.250	1.818	8.69	2	31.59		81.3698	
HSS8x8x5/16	5.828	31.79	2	370.55		4.2448	
	14.943	31.79	2	950.06		11.9792	
	11.313	31.79	2	719.25		25.0990	
	10.010	31.79	2	636.46		35.7500	
	10.021	31.79	2	637.12		45.7500	
	10.036	31.79	2	638.12		55.7500	
	10.057	31.79	2	639.44		65.7500	
	10.078	31.79	2	640.77		75.7500	
	9.188	31.79	2	584.14		85.7500	
			Total (for one truss)=	7674.61	lbs	42.1629	78.0000
			Total (for one truss)=	7.67	kips		
			x5 (for all 5 trusses)=	38.37	kips		

Wind Column Trusses						Center of Mass	
	Size	Length (ft)	lb/ft	Quantity	Weight (kips)	x (ft)	y (ft)
1	HSS8x8x5/16	5.854	31.79	1	0.186	11.9010	
	HSS7.500x0.312	1.250	23.97	1	0.030	11.9010	
	HSS3.500x0.216	6.651	7.58	1	0.050	11.9010	
2	HSS8x8x5/16	5.604	31.79	1	0.178	31.9010	
	HSS7.500x0.312	1.250	23.97	1	0.030	31.9010	
	HSS3.500x0.216	6.339	7.58	1	0.048	31.9010	
3	HSS8x8x5/16	4.510	31.79	1	0.143	51.9010	
	HSS7.500x0.312	1.250	23.97	1	0.030	51.9010	
	HSS3.500x0.216	5.385	7.58	1	0.041	51.9010	
4	HSS8x8x5/16	2.625	31.79	1	0.083	71.9010	
	HSS7.500x0.312	1.250	23.97	1	0.030	71.9010	
	HSS3.500x0.216	3.917	7.58	1	0.030	71.9010	
			TOTAL=	0.880	kips	37.2172	
			x 2=	1.760	kips		

Additional Framing					Center of Mass		
Size	Length (ft)	lb/ft	Quantity	Weight (kips)	x (ft)	y (ft)	
HSS8x8x5/16	147.495	31.79	1	4.689	3.7656	78.0000	
HSS4x4x1/4	10.750	12.18	6	0.786	22.9010	78.0000	
HSS8x6x1/4	24.000	22.39	12	6.448	22.9010	78.0000	
HSS8x8x5/16	10.750	31.79	2	0.683	51.9010	78.0000	
HSS8x8x5/16	24.000	31.79	4	3.052	51.9010	78.0000	
HSS6x6x1/4	20.000	18.99	30	11.394	51.4010	78.0000	
HSS8x8x5/16	88.135	31.79	2	5.604	47.8333	78.0000	
HSS8x6/1/2	88.135	41.91	2	7.388	47.8333	78.0000	
HSS6.250x0.250	147.495	17.04	1	2.513	51.9010	78.0000	
HSS6.625x0.280	80.000	18.99	2	3.038	51.9010	78.0000	
TOTAL=				45.595	kips	41.0660	78.0000

“Building 2” – Level 1

Building 2 - Level 1			
Weights of Building Components		Center of Mass	
Component	Weight	x (ft)	y (ft)
Concrete Grandstand	130.314 kips	113.1518	78.0000
(2) Stairs at Grandstand	30.382 kips	109.5729	78.0000
W27x94 (Bent and Sloped Beams)	4.005 kips	166.1094	78.0000
Balcony	162.813 kips	107.1264	78.0000
Total=	327.513 kips	113.7793	78.0000

Concrete Grandstand					Center of Mass	
	Size (SF)	Length (ft)	PCF	Weight (kips)	x (ft)	y (ft)
a	2.4424	126	150	46.161	111.2396	78.0000
b	2.3711	126	150	44.814		78.0000
c	2.0814	126	150	39.338		78.0000
TOTAL=				130.314		78.0000

Concrete Grandstand					Center of Mass	
	Size (SF)	Length (ft)	PCF	Weight (kips)	x (ft)	y (ft)
a	2.4424	126	150	46.161	111.2396	78.0000
b1	1.6230	126	150	30.675	112.5625	78.0000
b2	0.7480	126	150	14.137	113.9063	78.0000
c1	1.6230	126	150	30.675	115.2813	78.0000
c2	0.4583	126	150	8.662	116.6563	78.0000
TOTAL=				130.310	113.1518	78.0000

W27x94 (bent and sloped beams)					Center of Mass	
Size	Length (ft)	lb/ft	Quantity	Weight (kips)	x (ft)	y (ft)
W27x94	8.52083333	94	5	4.0048	166.1094	78.0000

(2) Sets of Concrete Stairs at Grandstand					Center of Mass	
	Size (SF)	Length (ft)	PCF	Weight (kips)	x (ft)	y (ft)
a	37.9774	2.667	150	15.191	109.5729	100.7500
b	37.9774	2.667	150	15.191	109.5729	55.2500
TOTAL=				30.382	109.5729	78.0000

Balcony					Center of Mass	
	Size (SF)	Length (ft)	PCF	Weight (kips)	x (ft)	y (ft)
	4.875	131	150	95.794	108.9010	78.0000
	2.7708	131	150	54.446	105.4844	78.0000
	41.1719	0.792	150	4.889	101.4010	6.6146
	41.1719	0.792	150	4.889	101.4010	149.3854
	11.7661	0.792	150	1.397	98.3177	4.6667
	11.7661	0.792	150	1.397	98.3177	151.3333
TOTAL=				162.813	107.1264	78.0000

“Building 2” – Level 2

Building 2 - Level 2			
Weights of Building Components		Center of Mass	
Component	Weight	x (ft)	y (ft)
Concrete Grandstand	215.967 kips	123.7292	78.0000
Interior Walls	113.812 kips	126.4783	70.0919
Total=	329.779 kips	124.6779	75.2708

Concrete Grandstand					Center of Mass	
	Size (SF)	Length (ft)	PCF	Weight (kips)	x (ft)	y (ft)
d	0.2897	126	150	5.475	116.6563	78.0000
e1	1.623	126	150	30.675	118.0313	78.0000
e2	0.748	126	150	14.137	119.4063	78.0000
f1	1.623	126	150	30.675	120.7813	78.0000
f2	0.748	126	150	14.137	122.1563	78.0000
g1	1.623	126	150	30.675	123.5313	78.0000
g2	0.748	126	150	14.137	124.9063	78.0000
h	4.0241	126	150	76.055	128.6823	78.0000
TOTAL=				215.967	123.7292	78.0000

Interior Walls (from Concourse Level to Gallery Level)						Center of Mass	
Height (ft)	Width (ft)	Length (ft)	PCF	Weight (kips)	x (ft)	y (ft)	
2.917	0.635	30.667	150	8.525	122.0677	121.6667	
2.917	0.635	49.667	150	13.807	122.0677	78.1667	
2.917	0.635	3.667	150	1.019	122.0677	48.3333	
4.841	0.635	15.901	150	7.333	124.7813	140.6667	
7.192	0.635	10.333	150	7.079	128.9531	136.6667	
6.917	0.635	3.333	150	2.196	128.9010	138.6667	
7.192	0.635	10.333	150	7.079	128.9531	109.3333	
4.841	0.635	15.901	150	7.333	124.7813	46.3333	
4.841	0.469	15.901	150	5.413	124.7813	19.4115	
4"	6.917	0.302	5.333	1.672	130.5677	133.6667	
4"	6.917	0.302	5.333	1.672	130.5677	112.3333	
4"	6.917	0.302	5.333	1.672	132.2344	133.6667	
4"	6.917	0.302	5.333	1.672	132.2344	112.3333	
4"	6.917	0.302	1.333	0.418	131.4010	131.1667	
4"	6.917	0.302	1.333	0.418	131.4010	114.8333	
4"	6.917	0.302	6.000	1.880	131.2344	43.0000	
4"	6.917	0.302	6.000	1.880	132.5677	43.0000	
4"	6.917	0.302	6.167	1.933	131.2344	22.7448	
4"	6.917	0.302	6.167	1.933	132.5677	22.7448	
8"	6.917	0.635	6.500	4.285	129.4844	39.6667	
8"	6.917	0.635	14.167	9.339	125.9010	32.9115	
6"	6.917	0.469	6.500	3.161	129.4844	34.4115	
6"	6.917	0.469	6.500	3.161	129.4844	31.4115	
6"	6.917	0.469	2.500	1.216	131.1510	32.9115	
8"	6.917	0.635	6.500	4.285	129.4844	26.1615	
8"	6.917	0.635	3.500	2.307	128.9010	17.4167	
4.841	0.635	15.901	150	7.337	124.7813	15.3333	
3.109	0.469	8.667	150	1.895	121.2344	33.7500	
3.109	0.469	8.667	150	1.895	121.2344	31.9115	
TOTAL=				113.812	126.4783	70.0919	

"Building 3" – Level 1

Building 3 - Level 1			
Weights of Building Components		Center of Mass	
Component	Weight	x (ft)	y (ft)
Precast Concrete Planks	427.386 kips	125.4010	78.0000
Concrete Stairs and Landing (North)	26.048 kips	130.4713	160.7292
Concrete Stairs and Landing (South)	20.123 kips	114.8116	-4.5521
Precast Concrete Ramp	82.596 kips	198.1712	10.0257
Interior Walls from Ground Level	342.366 kips	123.1031	77.7234
Interior Walls from Level 2	191.021 kips	130.6473	68.5422
Total=	1089.540 kips	125.7531	78.2569

12" Precast Concrete Hollow Core Floor Planks				Center of Mass	
	Surface Area (SF)	PSF	Weight	x (ft)	y (ft)
All to Column Line 1.8	1571.063	102	160.248	125.4010	78.0000
Most to Shear Walls	2619.000	102	267.138	125.4010	78.0000
TOTAL=			427.386	125.4010	78.0000

Interior Walls (from Ground Level)	Height (ft)	Width (ft)	Length (ft)	PCF	Weight (kips)	Center of Mass	
						x (ft)	y (ft)
a ("north" area)	4.083	1.000	19.000	150	11.637	107.4010	145.8333
a	4.083	0.667	30.000	150	12.250	120.8177	136.6667
a	4.083	1.000	19.667	150	12.046	138.4010	146.1667
a	4.083	0.667	14.583	150	5.955	130.6094	155.6667
a	4.083	0.667	14.885	150	6.078	122.9844	158.7760
a	4.083	0.667	4.000	150	1.633	131.6510	153.3333
a	4.083	0.667	8.000	150	3.267	127.3177	151.6667
b	4.083	1.000	32.667	150	20.008	107.4010	114.3333
b	4.083	0.667	30.000	150	12.250	122.9010	98.3333
b	4.083	1.000	32.667	150	20.008	138.4010	114.3333
b	4.083	0.667	30.000	150	12.250	122.9010	130.3333
b	4.083	0.667	4.000	150	1.633	126.9010	100.6667
b	4.083	0.333	10.667	150	2.178	132.5677	107.0000
b	4.083	0.667	12.500	150	5.104	126.9010	131.0833
b	4.083	0.333	9.333	150	1.906	131.9010	109.0000
b	4.083	0.333	14.667	150	2.994	136.7344	116.1667
b	4.083	0.667	6.500	150	2.654	126.9010	126.7500
b-c	4.083	0.667	5.333	150	2.178	109.9010	95.3333
b-c	4.083	0.667	5.333	150	2.178	128.2344	95.3333
c	4.083	1.000	35.750	150	21.897	121.0260	63.8333
c	4.083	1.000	35.750	150	21.897	121.0260	92.1667
c	4.083	0.667	27.333	150	11.161	113.9010	78.0000
c	4.083	0.667	3.625	150	1.480	109.0052	78.0000
c	4.083	0.333	2.167	150	0.442	110.9844	78.0000
c	4.083	0.333	2.417	150	0.493	112.3594	78.9167
c	4.083	0.333	2.417	150	0.493	112.3594	77.0833
c-d	4.083	0.667	5.333	150	2.178	109.9010	60.6667
c-d	4.083	0.667	5.333	150	2.178	128.2344	60.6667
d	4.083	1.000	26.000	150	15.925	107.4010	45.0000
d	4.083	0.667	12.000	150	4.900	113.9010	32.3333
d	4.083	0.667	10.667	150	4.356	132.5677	32.3333
d	4.083	1.000	26.000	150	15.925	138.4010	45.0000
d	4.083	0.667	30.000	150	12.250	122.9010	57.6667
d	4.083	0.500	6.167	150	1.889	123.4844	32.2500
d	4.083	0.500	1.333	150	0.408	120.1510	33.3333
d	4.083	0.500	6.167	150	1.889	123.4844	33.7500
d	4.083	0.667	1.833	150	0.749	136.0000	33.5833
d	4.083	0.333	9.000	150	1.837	135.8333	42.3333
d	4.083	0.333	9.000	150	1.837	136.6667	42.3333
d	4.083	0.333	0.500	150	0.102	136.2500	38.0000
d	4.083	0.667	2.333	150	0.953	136.0000	48.0000
d	4.083	0.333	10.667	150	2.178	141.6667	49.0000
d	4.083	0.333	9.667	150	1.974	141.1667	47.0000
d	4.083	0.333	14.167	150	2.892	145.8333	39.7500
d	4.083	0.667	4.000	150	1.633	126.9010	55.3333
e	4.083	1.000	31.333	150	19.192	107.4010	16.3333
e	4.083	1.000	7.583	150	4.645	138.4010	28.2083
e	4.083	1.000	11.083	150	6.789	138.4010	6.2083
e	4.083	0.667	31.333	150	12.794	116.4844	16.3333
e	4.083	0.667	8.250	150	3.369	112.0260	18.0000
e	4.083	0.333	14.333	150	2.926	123.9844	19.0625
e	4.083	0.333	15.250	150	3.114	124.4427	16.9375
e	4.083	0.333	7.854	150	1.604	131.3177	22.8229
e	4.083	0.667	0.917	150	0.374	131.9427	26.4167
e	4.083	0.333	9.646	150	1.969	132.5677	21.9271
e	4.083	0.667	7.354	150	3.003	132.4010	13.0938
e	4.083	0.667	3.667	150	1.497	132.4010	4.2500
e	4.083	0.333	21.083	150	4.305	128.1094	2.2500
e	4.083	0.667	5.167	150	2.110	135.3177	11.4167
e	4.083	0.667	5.167	150	2.110	135.3177	24.7500
e	4.083	0.667	1.083	150	0.442	132.4010	31.0417
TOTAL=					342.366	123.1031	77.7234

Interior Walls (from Level 2)					Center of Mass	
Height (ft)	Width (ft)	Length (ft)	PCF	Weight (kips)	x (ft)	y (ft)
6.538	0.667	21.000	150.000	13.729	121.9010	140.6667
7.083	0.667	3.333	150.000	2.361	128.9010	138.6667
7.083	0.667	10.667	150.000	7.556	136.1667	136.6667
7.083	0.667	30.000	150.000	21.250	131.1667	121.3333
7.083	0.667	49.667	150.000	35.181	131.1667	78.1667
7.083	0.667	3.333	150.000	2.361	131.1667	48.3333
7.083	0.333	5.333	150.000	1.889	139.6667	133.6667
7.083	0.333	1.333	150.000	0.472	140.5000	131.1667
7.083	0.333	5.333	150.000	1.889	141.6667	133.6667
7.083	0.333	5.333	150.000	1.889	139.6667	112.3333
7.083	0.333	1.333	150.000	0.472	140.5000	114.8333
7.083	0.333	5.333	150.000	1.889	141.6667	112.3333
7.083	0.667	3.333	150.000	2.361	133.1667	109.3333
7.083	0.667	3.333	150.000	2.361	139.8333	109.3333
7.083	0.667	16.500	150.000	11.687	133.5833	46.3333
7.083	0.667	12.000	150.000	8.500	125.6667	40.0000
7.083	0.500	9.333	150.000	4.958	130.0000	33.7500
7.083	0.500	9.333	150.000	4.958	130.0000	31.9115
7.083	0.667	12.000	150.000	8.500	125.6667	25.6615
7.083	0.500	16.500	150.000	8.766	133.5833	19.4115
7.083	0.667	3.495	150.000	2.475	138.0000	17.4167
6.519	0.667	21.333	150.000	13.906	131.1667	15.3333
7.083	0.333	6.167	150.000	2.184	140.3333	22.7448
7.083	0.333	6.167	150.000	2.184	141.6667	22.7448
7.083	0.667	3.000	150.000	2.125	140.3333	26.1615
7.083	0.667	0.500	150.000	0.354	135.5833	26.1615
7.083	0.667	14.167	150.000	10.035	135.0000	32.9115
7.083	0.500	6.500	150.000	3.453	138.5833	31.4115
7.083	0.500	6.500	150.000	3.453	138.5833	34.4115
7.083	0.500	2.500	150.000	1.328	140.2500	32.9115
7.083	0.667	0.500	150.000	0.354	135.5833	39.6667
7.083	0.667	2.667	150.000	1.889	140.5000	39.6667
7.083	0.333	6.000	150.000	2.125	140.3333	43.0000
7.083	0.333	6.000	150.000	2.125	141.6667	43.0000
TOTAL=				191.021	130.6473	68.5422

Concrete Stairs and Landing (North)				Center of Mass	
Area (SF)	Width (ft)	PCF	Weight (kips)	x (ft)	y (ft)
18.360	9.458	150.000	26.048	130.4713	160.7292

Concrete Stairs and Landing (South)				Center of Mass	
Area (SF)	Width (ft)	PCF	Weight (kips)	x (ft)	y (ft)
16.382	7.104	150.000	17.457		

Concrete Stairs and Landing (South)					Center of Mass	
	Area (SF)	Width (ft)	PCF	Weight (kips)	x (ft)	y (ft)
Steps	10.228	7.104	150	10.900	111.089	-4.5521
10" Slab/Landing	3.739	7.104	150	3.984	115.818	-4.5521
8" Slab/Landing	4.917	7.104	150	5.239	121.7917	-4.5521
TOTAL=				20.123	114.8116	-4.5521

Precast Concrete Ramp					Center of Mass	
	Surface Area (SF)	Thickness (ft)	PCF	Weight (kips)	x (ft)	y (ft)
Lower Part of Ramp	412.157	0.667	150.000	41.216	216.5000	23.9219
Upper Part of Ramp	304.071	0.667	150.000	30.407	197.0417	-3.7448
Landing/Slab	109.733	0.667	150.000	10.973	132.4583	-4.0104
TOTAL=				82.596	198.1712	10.0257

“Building 4” – Level 2

Building 4 - Level 2			
Weights of Building Components		Center of Mass	
Component	Weight	x (ft)	y (ft)
Roofing Above Lobby	337.055 kips	152.6354	78.0000
Trusses Above Lobby	22.230 kips	150.3677	76.7767
Gallery Level Framing	51.671 kips	144.9739	56.2096
Canopy Framing	8.618 kips	165.1920	132.4399
Columns in Lobby	8.260 kips	157.7642	66.9078
Precast Concrete Panels	265.228 kips	166.9367	79.0722
Mechanical Unit Support Framing	19.089 kips	149.2219	78.5808
Mechanical Units	48.500 kips	146.5257	76.8963
760.650 kips		151.5494	75.1941

Trusses Above Lobby						Center of Mass	
	Size	Length (ft)	lb/ft	Quantity	Weight (kips)	x (ft)	y (ft)
1	HSS6x6x3/8	41.333	27.41	1	1.133	150.9844	18.0000
	HSS6.625x0.375	36.167	25.06	1	0.906	150.9844	18.0000
	HSS3.500x0.250	3.536	8.69	16	0.492	150.9844	18.0000
2	HSS6x6x3/8	41.333	27.41	1	1.133	150.9844	33.0000
	HSS6.625x0.375	36.167	25.06	1	0.906	150.9844	33.0000
	HSS3.500x0.250	3.536	8.69	16	0.492	150.9844	33.0000
3	HSS6x6x3/8	41.333	27.41	1	1.133	150.9844	48.0000
	HSS6.625x0.375	36.167	25.06	1	0.906	150.9844	48.0000
	HSS3.500x0.250	3.536	8.69	16	0.492	150.9844	48.0000
4	HSS6x6x3/8	41.333	27.41	1	1.133	150.9844	63.0000
	HSS6.625x0.375	36.167	25.06	1	0.906	150.9844	63.0000
	HSS3.500x0.250	3.536	8.69	16	0.492	150.9844	63.0000
5	HSS6x6x3/8	41.333	27.41	1	1.133	150.9844	78.0000
	HSS6.625x0.375	36.167	25.06	1	0.906	150.9844	78.0000
	HSS3.500x0.250	3.536	8.69	16	0.492	150.9844	78.0000
6	HSS6x6x3/8	40.688	27.41	1	1.115	150.3646	93.0000
	HSS6.625x0.375	35.672	25.06	1	0.894	150.3646	93.0000
	HSS3.500x0.250	3.536	8.69	16	0.492	150.3646	93.0000
7	HSS6x6x3/8	39.625	27.41	1	1.086	150.1979	108.0000
	HSS6.625x0.375	35.313	25.06	1	0.885	150.1979	108.0000
	HSS3.500x0.250	3.536	8.69	16	0.492	150.1979	108.0000
8	HSS6x6x3/8	37.932	27.41	1	1.040	149.3490	123.0000
	HSS6.625x0.375	33.615	25.06	1	0.842	149.3490	123.0000
	HSS3.500x0.250	3.536	8.69	16	0.492	149.3490	123.0000
9	HSS6x6x3/8	35.599	27.41	1	0.976	148.1510	138.0000
	HSS6.625x0.375	30.719	25.06	1	0.770	148.1510	138.0000
	HSS3.500x0.250	3.536	8.69	16	0.492	148.1510	138.0000
TOTAL=					22.230	150.3677	76.7767

Gallery Level Framing (Above Lobby)						Center of Mass	
Size	Length (ft)	lb/ft	Quantity	Weight (kips)	x (ft)	y (ft)	
W12x22	20.167	22	1	0.444	161.3177	-0.4792	
W12x22	20.167	22	1	0.444	161.3177	-3.1458	
W12x22	20.167	22	1	0.444	161.3177	-5.8125	
W14x22	19.854	22	1	0.437	161.3333	-8.8958	
W12x22	20.167	22	1	0.444	140.6510	-0.4792	
W12x22	20.167	22	1	0.444	140.6510	-3.1458	
W12x22	20.167	22	1	0.444	140.6510	-5.8125	
W14x22	19.849	22	1	0.437	140.6510	-8.3750	
W12x22	13.604	22	4	1.197	123.2656	-4.3542	
W10x12	7.750	12	1	0.093	116.3802	-4.4792	
W10x12	8.010	12	1	0.096	80.4219	-4.4740	
W10x12	8.010	12	1	0.096	115.8802	-4.4740	
W10x12	17.729	12	2	0.426	106.9740	-4.4740	
W10x12	17.729	12	2	0.426	89.3073	-4.4740	
C8x11.5	8.010	11.5	7	0.645	98.1510	-4.4792	
HSS8x6x3/8	13.604	32.51	1	0.442	123.2656	-9.1979	
HSS8x6x3/8	20.172	32.51	1	0.656	140.6510	-9.5260	
HSS8x6x3/8	20.427	32.51	1	0.664	161.4479	-9.9219	
W24x94	27.141	94	1	2.551	171.6510	4.3021	
W10x15	16.750	15	1	0.251	171.9010	9.5000	
HSS12x6x1/4	16.750	17.3	1	0.290	172.4323	9.6250	
HSS4x4x1/4	16.750	12.18	1	0.204	166.4844	9.6250	
HSS6x6x1/4	16.750	18.99	1	0.318	156.1510	9.6250	
W24x117	26.6354	117	1	3.116	150.9844	4.7604	
HSS3x3x1/4	10.3333	8.78	1	0.091	161.3177	10.1354	
W14x30	20.667	30	1	0.620	161.3177	1.5000	
HSS6x6x5/16	20.667	23.29	1	0.481	161.3177	1.2500	
W14x30	20.667	30	1	0.620	140.6510	1.5000	
W24x117	26.229	117	1	3.069	130.3177	4.6563	
HSS6x6x1/4	16.750	18.99	1	0.318	145.8177	9.6250	
HSS6x6x1/4	16.750	18.99	1	0.318	135.4844	9.6250	
HSS4x4x1/4	16.750	12.18	1	0.204	133.7656	9.6250	
HSS3x3x1/4	5.167	8.78	1	0.045	153.5677	10.1354	
HSS3x3x1/4	5.167	8.78	1	0.045	148.4010	10.1354	
<i>Truss 1</i>							
HSS12x6x1/4	15.000	17.3	1	0.260	172.4948	25.5000	
W14x22	15.000	22	1	0.330	171.6510	25.5000	
HSS4x4x1/4	15.000	12.18	1	0.183	166.4844	25.5000	
HSS6x6x1/4	15.000	18.99	3	0.855	145.8177	25.5000	
HSS3x3x1/4	10.3333	8.78	3	0.272	150.9844	25.5000	
HSS12x12x3/8	30.000	58.03	1	1.741	130.3177	33.0000	
HSS7x4x1/4	30.000	17.28	1	0.518	130.3177	33.0000	
<i>Truss 2</i>							
HSS12x6x1/4	15.000	17.3	1	0.260	172.4948	40.5000	
W14x22	15.000	22	1	0.330	171.6510	40.5000	
HSS4x4x1/4	15.000	12.18	1	0.183	166.4844	40.5000	
HSS6x6x1/4	15.000	18.99	4	1.139	148.4010	40.5000	
HSS3x3x1/4	10.3333	8.78	2	0.181	156.1510	40.5000	
HSS3x3x1/4	5.167	8.78	2	0.091	140.6510	40.5000	
<i>Truss 3</i>							
HSS12x6x1/4	15.000	17.3	1	0.260	172.4948	55.5000	
W14x22	15.000	22	1	0.330	171.6510	55.5000	
HSS4x4x1/4	15.000	12.18	1	0.183	166.4844	55.5000	
HSS6x6x1/4	15.000	18.99	3	0.855	145.8177	55.5000	
HSS3x3x1/4	10.3333	8.78	3	0.272	150.9844	55.5000	
HSS12x12x3/8	30.000	58.03	1	1.741	130.3177	55.5000	
HSS7x4x1/4	30.000	17.28	1	0.518	130.3177	63.0000	

<i>Truss 4</i>							
HSS12x6x1/4	15.000	17.3	1	0.260	172.4948	70.5000	
W14x22	15.000	22	1	0.330	171.6510	70.5000	
HSS4x4x1/4	15.000	12.18	1	0.183	166.4844	70.5000	
HSS6x6x1/4	15.000	18.99	3	0.855	145.8177	70.5000	
HSS3x3x1/4	10.3333	8.78	1	0.091	161.3177	70.5000	
HSS4x4x1/4	10.333	12.18	4	0.503	145.8177	71.5625	
HSS4x4x1/4	5.250	12.18	2	0.128	151.4583	69.8750	
HSS4x4x1/4	3.000	12.18	3	0.110	139.1979	73.2396	
<i>Truss 5</i>							
HSS12x6x1/4	15.000	17.3	1	0.260	172.3854	85.5000	
W14x22	15.000	22	1	0.330	171.4063	85.5000	
HSS4x4x1/4	15.000	12.18	4	0.731	150.9844	85.5000	
HSS3x3x1/4	10.3333	8.78	3	0.272	150.9844	85.5000	
HSS12x12x3/8	30.000	58.03	1	1.741	130.3177	93.0000	
HSS7x4x1/4	30.000	17.28	1	0.518	130.3177	93.0000	
<i>Truss 6</i>							
HSS12x6x1/4	15.000	17.3	1	0.260	171.5938	100.5000	
W14x22	15.000	22	1	0.330	170.6250	100.5000	
HSS4x4x1/4	15.000	12.18	4	0.731	150.9844	100.5000	
HSS3x3x1/4	10.3333	8.78	3	0.272	150.9844	100.5000	
<i>Truss 7</i>							
HSS12x6x1/4	15.000	17.3	1	0.260	170.1354	115.5365	
W14x22	15.000	22	1	0.330	169.2344	115.5000	
HSS4x4x1/4	15.000	12.18	4	0.731	155.7240	115.5000	
HSS3x3x1/4	9.5	8.78	1	0.083	160.9010	115.5000	
HSS3x3x1/4	10.3333	8.78	1	0.091	150.9844	115.5000	
HSS12x12x3/8	30.000	58.03	1	1.741	130.3177	123.0000	
HSS7x4x1/4	30.000	17.28	1	0.518	130.3177	123.0000	
<i>Truss 8</i>							
HSS12x6x1/4	15.083	17.3	1	0.261	168.1615	130.5625	
W14x22	15.083	22	1	0.332	167.2500	130.5000	
HSS4x4x1/4	15.406	12.18	1	0.188	163.0781	130.5000	
HSS4x4x1/4	15.000	12.18	3	0.548	145.8177	130.5000	
HSS3x3x1/4	6.901	8.78	1	0.061	159.6146	130.5000	
HSS3x3x1/4	10.3333	8.78	1	0.091	150.9844	130.5000	
<i>Truss 9</i>							
HSS12x6x1/4	16.750	17.3	1	0.290	165.0990	146.5625	
W14x22	16.750	22	1	0.369	164.4479	146.3750	
HSS4x4x1/4	16.750	12.18	4	0.816	153.2083	146.3750	
W14x43	16.750	43	1	0.720	130.3177	146.5417	
HSS3x3x1/4	5.167	8.78	1	0.045	158.7344	146.3750	
HSS3x3x1/4	10.333	8.78	1	0.091	150.9844	146.3750	
W14x30	9.563	30	1	0.287	157.3490	154.7500	
HSS6x6x5/16	9.563	23.29	1	0.223	157.3490	154.5000	
W14x30	21.583	30	1	0.647	141.1094	154.7500	
W10x26	21.583	26	1	0.561	141.1094	155.0000	
W10x26	18.417	26	1	0.479	120.9010	154.7500	
W10x26	13.333	26	1	0.347	111.9010	158.8333	
C8x11.5	11.083	11.5	8	1.020	132.6302	160.3333	
W10x26	10.833	26	1	0.282	151.9010	160.2917	
W10x26	21.583	26	1	0.561	141.1094	165.8333	
W10x26	18.417	26	1	0.479	121.1094	165.8333	
TOTAL=				51.671	144.9739	56.2096	

Columns in Lobby						Center of Mass	
Size	Length (ft)	lb/ft	Quantity	Weight (kips)	x (ft)	y (ft)	
HSS10x10x3/8	11.500	47.82	1	0.55	150.9844	1.2500	
HSS10x10x3/8	11.500	47.82	1	0.55	171.6510	1.2500	
HSS10x10x3/8	11.500	47.82	1	0.55	171.6510	18.0000	
HSS10x10x3/8	11.500	47.82	1	0.55	171.6510	33.0000	
HSS10x10x3/8	11.500	47.82	1	0.55	171.6510	48.0000	
HSS10x10x3/8	11.500	47.82	1	0.55	171.6510	63.0000	
HSS10x10x3/8	11.500	47.82	1	0.55	171.6510	78.0000	
HSS10x10x3/8	11.500	47.82	1	0.55	171.1615	93.0000	
HSS10x10x3/8	11.500	47.82	1	0.55	170.0781	108.0000	
HSS10x10x3/8	11.500	47.82	1	0.55	168.3906	123.0000	
HSS10x10x3/8	11.500	47.82	1	0.55	166.0990	138.0000	
HSS10x10x3/8	11.500	47.82	1	0.55	162.7969	154.7500	
HSS10x10x3/8	11.500	47.82	1	0.55	151.9010	154.7500	
HSS18x18x5/8	37.333	47.82	5				
HSS12x12x5/16	51.188	48.81	2				
HSS6x6x1/4	9.750	18.99	6	1.11	98.1719	-4.4740	
HSS10x10x3/8	22.911	47.82	1				
HSS12x12x5/16	51.495	48.81	2				
HSS14x14x5/8	13.042	110	5				
HSS10x10x3/8	22.208	47.82	1				
HSS6x6x1/4	10.000	18.99	2				
HSS8x8x1/4	12.521	25.79	3				
TOTAL=				8.26	157.7642	66.9078	

Canopy Framing						Center of Mass	
Size	Length (ft)	lb/ft	Quantity	Weight (kips)	x (ft)	y (ft)	
C12x20.7	12.563	20.700	1	0.260	167.1198	88.5000	
W14x22	10.547	22.000	1	0.232	165.8906	93.0000	
W14x22	10.599	22.000	1	0.233	164.7813	108.0000	
W14x22	10.651	22.000	1	0.234	162.5156	123.0000	
W14x22	10.708	22.000	1	0.236	160.7448	138.0000	
W14x43	10.896	43.000	1	0.469	157.3490	154.7500	
C12x20.7	19.297	20.700	1	0.399	160.2969	98.1354	
C12x20.7	14.599	20.700	1	0.302	158.6875	115.5104	
C12x20.7	14.677	20.700	1	0.304	156.6458	130.5104	
C12x20.7	16.458	20.700	1	0.341	153.8125	146.3333	
C12x20.7	3.589	20.700	1	0.074	171.2604	90.5417	
C12x20.7	13.708	20.700	1	0.284	170.4531	100.5000	
C12x20.7	13.766	20.700	1	0.285	169.0677	115.5000	
C12x20.7	13.854	20.700	1	0.287	167.0781	130.5000	
C12x20.7	15.724	20.700	1	0.325	164.3646	146.3750	
C12x20.7	19.250	20.700	1	0.398	173.4010	98.1250	
C12x20.7	14.500	20.700	1	0.300	173.4010	115.5000	
C12x20.7	14.500	20.700	1	0.300	173.4010	130.5000	
C12x20.7	16.250	20.700	1	0.336	173.4010	146.3750	
C12x20.7	8.917	20.700	1	0.185	173.4010	159.4583	
W14x43	10.000	43.000	1	0.430	168.4323	154.7500	
W10x15	8.500	15.000	1	0.128	162.7969	159.6667	
W10x15	9.833	15.000	1	0.147	152.1510	160.3333	
C8x11.5	10.104	11.500	1	0.116	168.0990	159.7500	
C8x11.5	10.146	11.500	1	0.117	157.4740	156.2500	
C8x11.5	10.146	11.500	1	0.117	157.4740	160.3750	
HSS8x8x5/16	9.417	31.790	1	0.299	168.1094	164.5000	
HSS8x8x5/16	9.833	31.790	1	0.313	157.3177	164.5000	
HSS8x4x1/4	9.417	18.990	1	0.179	168.1094	164.5000	
HSS8x4x1/4	9.833	18.990	1	0.187	157.3177	164.5000	
W14x22	1.318	22.000	1	0.029	172.4896	93.0000	
C8x11.5	2.281	11.500	1	0.026	172.0104	98.0000	
C8x11.5	2.646	11.500	1	0.030	171.8281	103.0000	
W14x22	2.656	22.000	1	0.058	172.0729	108.0000	
C8x11.5	3.568	11.500	1	0.041	171.3646	113.0000	
C8x11.5	4.130	11.500	1	0.047	171.0833	118.0000	
W14x22	4.339	22.000	1	0.095	171.2292	123.0000	
C8x11.5	5.458	11.500	1	0.063	170.4219	128.0000	
C8x11.5	6.229	11.500	1	0.072	170.0365	133.0000	
W14x22	6.635	22.000	1	0.146	170.0833	138.0000	
C8x11.5	7.870	11.500	1	0.091	169.2135	143.0000	
C8x11.5	8.854	11.500	1	0.102	168.7240	148.0000	
TOTAL=				8.618	165.1920	132.4399	

Mechanical Unit Support Framing					Center of Mass	
Size	Length (ft)	lb/ft	Quantity	Weight (kips)	x (ft)	y (ft)
W8x24	15.5	24	1	0.372	147.2344	1.2500
C8x11.5	16.75	11.5	2	0.385	147.8177	9.6250
W8x15	16.75	15	3	0.754	143.9427	9.6250
C8x11.5	4	11.5	4	0.184	147.2344	9.6250
C8x11.5	7.5	11.5	1	0.086	147.2344	6.0000
W8x24	15.5	24	1	0.372	147.2344	18.0000
C8x11.5	15	11.5	2	0.345	147.2344	25.5000
W8x15	15	15	3	0.675	143.9427	25.5000
C8x11.5	4	11.5	4	0.184	143.9427	25.5000
W8x24	11.5	24	1	0.276	144.9844	33.0000
W8x24	13.276	24	1	0.319	157.8750	33.0000
W8x10	18.4167	10	1	0.184	164.2604	42.3333
W8x10	15	10	2	0.300	159.5000	40.5000
W8x15	15	15	3	0.675	143.9427	40.5000
C8x11.5	15	11.5	1	0.173	139.4844	40.5000
C8x11.5	1.66667	11.5	2	0.038	140.0677	40.5000
C8x11.5	2.9427	11.5	1	0.034	162.7917	38.1667
C8x11.5	3.6406	11.5	1	0.042	159.5000	38.1667
C8x11.5	6.6927	11.5	2	0.154	154.3333	40.5000
W8x24	13.276	24	1	0.319	157.7500	48.0000
W8x24	10.3333	24	1	0.248	144.9844	48.0000
C8x11.5	6.5833	11.5	1	0.076	160.9688	51.4167
C8x11.5	7.5	11.5	1	0.086	147.2344	51.4167
C8x11.5	15	11.5	1	0.173	157.6771	55.5000
W8x15	15	15	2	0.450	147.2344	55.5000
C8x11.5	6.6927	11.5	2	0.154	154.3333	55.5000
W10x22	20.66667	22	2	0.909	150.9844	64.4948
C8x11.5	2.9896	11.5	4	0.138	150.9844	64.4948
W8x18	15	18	2	0.540	150.9844	71.1354
W10x22	20.66667	22	5	2.273	150.9844	87.9583
C8x11.5	7.6979	11.5	2	0.177	150.9844	69.8385
C8x11.5	4.3125	11.5	4	0.198	150.9844	75.7969
C8x11.5	4.3333	11.5	4	0.199	150.9844	80.2031
C8x11.5	5.5	11.5	2	0.127	150.9844	85.0833
C8x11.5	5.166667	11.5	4	0.238	150.9844	90.4167
C8x11.5	15	11.5	1	0.173	139.4844	100.5000
W8x15	15	15	3	0.675	146.5260	100.5000
C8x11.5	6.6927	11.5	2	0.154	154.3333	100.5000
C8x11.5	6.5833	11.5	1			
C8x11.5	7.5	11.5	1	0.086	147.2344	104.5833
W8x10	18.4167	10	1	0.184	164.2604	113.6667
W8x10	15	10	2	0.300	159.5000	115.5000
W8x24	13.276	24	1	0.319	157.8750	108.0000
W8x24	11.5	24	1	0.276	144.9844	108.0000
W8x15	15	15	3	0.675	146.5260	115.5000
C8x11.5	15	11.5	1	0.173	139.4844	115.5000
C8x11.5	1.66667	11.5	2	0.038	140.0677	115.5000
C8x11.5	2.9427	11.5	1	0.034	162.7917	117.8333
C8x11.5	3.6406	11.5	1	0.042	159.5000	117.8333
C8x11.5	6.6927	11.5	2	0.154	154.3333	115.5000
W8x24	13.276	24	1	0.319	157.8750	123.0000
W8x24	11.5	24	1	0.276	144.9844	123.0000
C8x11.5	15	11.5	2	0.345	146.5260	130.5000
W8x15	15	15	3	0.675	146.5260	130.5000
C8x11.5	4	11.5	4	0.184	147.2344	130.5000
W8x24	15.5	24	1	0.372	147.2344	138.0000
C8x11.5	16.75	11.5	2	0.385	147.2344	146.3750
W8x15	16.75	15	3	0.754	146.5260	146.3750
C8x11.5	4	11.5	4	0.184	147.2344	146.3750
C8x11.5	7.5	11.5	1	0.086	147.2344	150.0000
W8x24	15.5	24	1	0.372	147.2344	154.7500
TOTAL=				19.089	149.2219	78.5808

Precast Concrete Panels	Area (SF)	PSF	Weight (kips)	Center of Mass	
				x (ft)	y (ft)
North Precast Elevation	354.497	100	35.450	152.1094	166.3333
South Precast Elevation	366.568	100	36.657	151.6094	0.3333
East Precast Elevation	1931.213	100	193.121	172.5677	78.0000
TOTAL=			265.228	166.9367	79.0722

Mechanical Units	Weight (kips)	Center of Mass	
		x (ft)	y (ft)
NEC-1	18.000	147.2344	127.2708
HRV-1	6.000	136.4844	78.0052
AAON	6.500	151.8698	69.8177
NEC-2	18.000	147.2344	28.7083
TOTAL=	48.500	146.5257	76.8963

Roofing Above Lobby	Surface Area (SF)	PSF	Weight (kips)	Center of Mass	
				x (ft)	y (ft)
	6073.057	55.500	337.055	152.6354	78.0000

Appendix B – Direct Load Calculations

Direct Loads: $F_{iy} = [k_{iy}/\sum k_{iy}] (P_y)$

North/South Direction

Building 1: Wind Loads (unfactored)

Level 1:

Braced Frame (column line 1):

$$F_{iy} = [89.3176/(5*89.3176)](40.2987 \text{ k}) = 8.0597 \text{ k}$$

Level 2:

Braced Frame (column line 1):

$$F_{iy} = [29.3737/((5*29.3737)+131.1475)](45.4993 \text{ k}) = 4.8072 \text{ k}$$

Braced Frame (column line 2):

$$F_{iy} = [131.1475/((5*29.3737)+131.1475)](45.4993 \text{ k}) = 21.4632 \text{ k}$$

Level 3:

Braced Frame (column line 1):

$$F_{iy} = [14.2330/((5*14.2330)+100.4823)](45.0111 \text{ k}) = 3.7323 \text{ k}$$

Braced Frame (column line 2):

$$F_{iy} = [14.2330/((5*14.2330)+100.4823)](45.0111 \text{ k}) = 26.3494 \text{ k}$$

Level 4:

Braced Frame (column line 1):

$$F_{iy} = [6.6924/(5*6.6924)](14.0340 \text{ k}) = 2.8068 \text{ k}$$

Building 1: Seismic Loads (unfactored)

Level 1:

Braced Frame (column line 1):

$$F_{iy} = [89.3176/(5*89.3176)](13.03 \text{ k}) = 2.606 \text{ k}$$

Level 2:

Braced Frame (column line 1):

$$F_{iy} = [29.3737/((5*29.3737)+131.1475)](35.9602 \text{ k}) = 3.7994 \text{ k}$$

Braced Frame (column line 2):

$$F_{iy} = [131.1475 / ((5 * 29.3737) + 131.1475)] (35.9602 \text{ k}) = 16.9634 \text{ k}$$

Level 3:

Braced Frame (column line 1):

$$F_{iy} = [14.2330 / ((5 * 14.2330) + 100.4823)] (15.2063 \text{ k}) = 1.2609 \text{ k}$$

Braced Frame (column line 2):

$$F_{iy} = [14.2330 / ((5 * 14.2330) + 100.4823)] (15.2063 \text{ k}) = 8.9018 \text{ k}$$

Level 4:

Braced Frame (column line 1):

$$F_{iy} = [6.6924 / (5 * 6.6924)] (33.9860 \text{ k}) = 6.7972 \text{ k}$$

Building 2: No Wind Load

Building 2: Seismic Loads (unfactored)

Level 1:

Moment Frame (column line 1.8):

$$F_{iy} = (703.2349 / 703.2349) (29.17 \text{ k}) = 29.17 \text{ k}$$

Level 2:

Braced Frame (column line 2):

$$F_{iy} = (131.1275 / 131.1475) (69.01 \text{ k}) = 69.01 \text{ k}$$

Building 3: No Wind Load

Building 3: Seismic Load (unfactored)

Level 1:

Distribute seismic force due to 160.2484 k of weight of precast concrete planks solely to moment frame at column line 1.8 (this is the area of precast planks that is not tied into shear walls at the eastward end, so assume that this entire load is taken only by the moment frame at column line 1)

$$F = (C_s)(W) = (0.06491)(160.2484 \text{ k}) = 10.4017 \text{ k}$$

Moment Frame (column line 1.8):

$$F_{iy1} = 10.4017 \text{ k}$$

$$1089.540 \text{ k} - 160.2485 \text{ k} = 929.2916 \text{ k}$$

$F = (C_s)(W) = 60.3203$ (this remaining load gets distributed amongst the moment frame and shear walls according to stiffness values)

Moment Frame (column line 1.8):

$$F_{iy2} = (703.2349/129587.7211)(60.3203 \text{ k}) = 0.3273 \text{ k}$$

Moment Frame (column line 1.8):

$$F_{iy\text{total}} = F_{iy1} + F_{iy2} = 10.4017 \text{ k} + 0.3273 \text{ k} = 10.7291 \text{ k}$$

Shear Wall 1:

$$F_{iy} = (23990.4774/129587.7211)(60.3203) = 11.1671 \text{ k}$$

Shear Wall 2:

$$F_{iy} = (47216.1117/129587.7211)(60.3203) = 21.9781 \text{ k}$$

Shear Wall 3:

$$F_{iy} = (48817.3481/129587.7211)(60.3203) = 22.7234 \text{ k}$$

Shear Wall 4:

$$F_{iy} = (8866.5491/129587.7211)(60.3203) = 4.1272 \text{ k}$$

Building 4: Wind Loads (unfactored)

Level 2:

Braced Frame (column line 2):

$$F_{iy} = [131.1475/(131.1475+21.3876)](16.3563 \text{ k}) = 14.0629 \text{ k}$$

Moment Frame (column line 4):

$$F_{iy} = [21.3876/(131.1475+21.3876)](16.3563 \text{ k}) = 2.2934 \text{ k}$$

Level 3:

Braced Frame (column line 2):

$$F_{iy} = [100.4823/100.4823](0.4294 \text{ k}) = 0.4294 \text{ k}$$

Building 4: Seismic Loads (unfactored)

Level 2:

Braced Frame (column line 2):

$$F_{iy} = [131.1475 / (131.1475 + 21.3876)](49.3738 \text{ k}) = 42.4509 \text{ k}$$

Moment Frame (column line 4):

$$F_{iy} = [21.3876 / (131.1475 + 21.3876)](49.3738 \text{ k}) = 6.9229 \text{ k}$$

Total Direct Wind Loads (North/South) – Factored (1.6W)

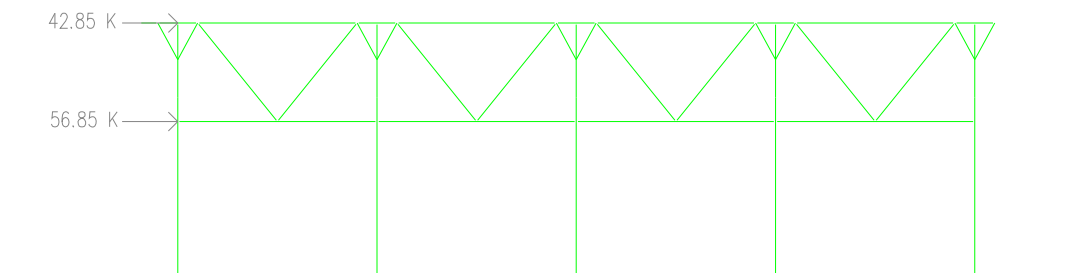
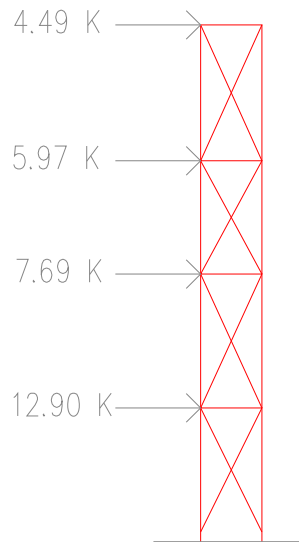

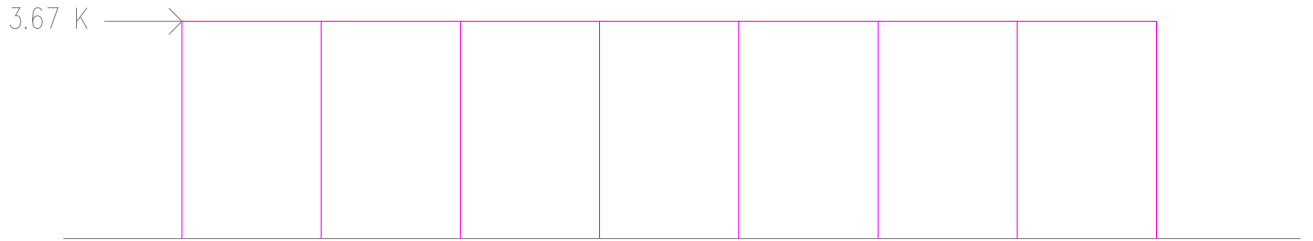

Total Direct Seismic Loads (North/South) – Factored 1.0E

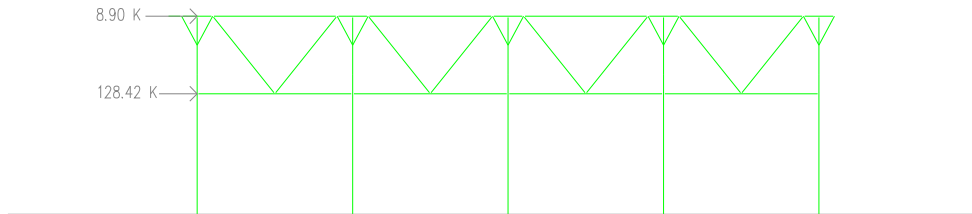
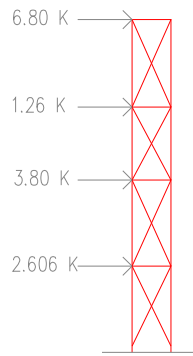

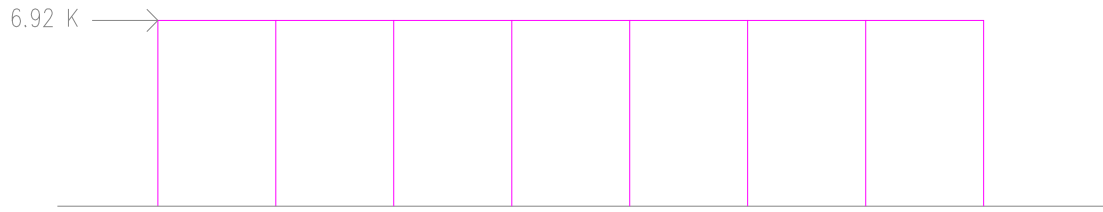

Appendix C – Torsional Load Calculations

Torsional Load: $F_{it} = k_i d_i P_y e_x / (\sum k_j d_j^2)$

For torsional loads, the entire building was analyzed per level instead of using “Buildings 1, 2, 3, and 4”. The results can be seen below.

North/South Direction:

Level 1: Seismic Load (unfactored)

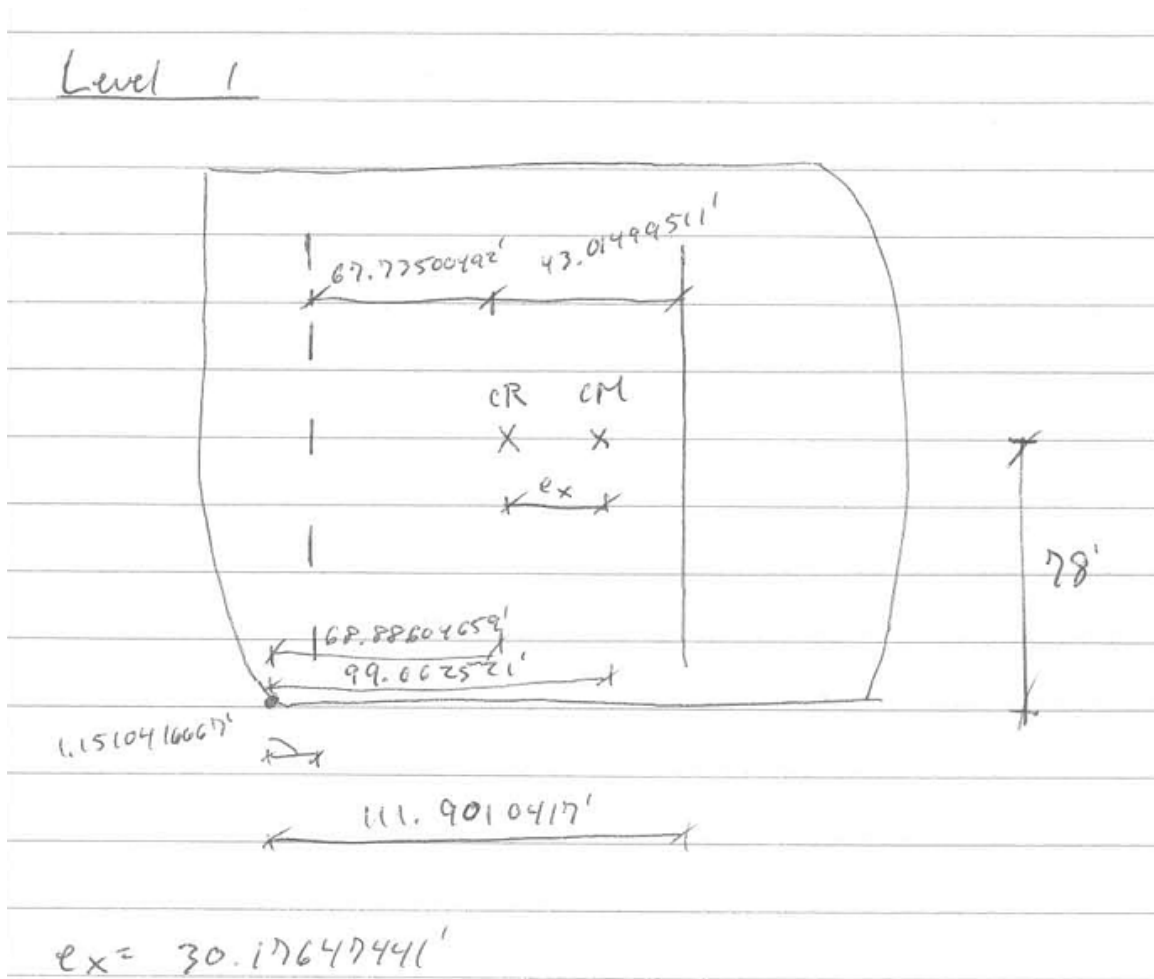

$e_x = 99.0625' - 68.8860' = 30.1765'$

$P_y = 13.0625 \text{ k} + 29.1725 \text{ k} + 70.7220 \text{ k} = 112.921 \text{ k}$

$\sum k_j d_j^2 = [(5)(89.3176)(67.7350')^2 + (703.2349)(43.0150')^2 + (2)(391.3894)(30')^2 + (2)(391.3894)(60')^2] = 6872653.015$

Braced Frame (column line 1):

$$\text{Fit} = (89.3176 \text{ k/in})(67.7350')(112.921 \text{ k})(30.1765') / 6872653.015 = 3.000 \text{ k}$$

Moment Frame (column line 1.8):

$$\text{Fit} = (703.2349 \text{ k/in})(43.0150)(112.921 \text{ k})(30.1765') / 6872653.015 = 14.9982 \text{ k}$$

Level 2: Seismic Load (unfactored)

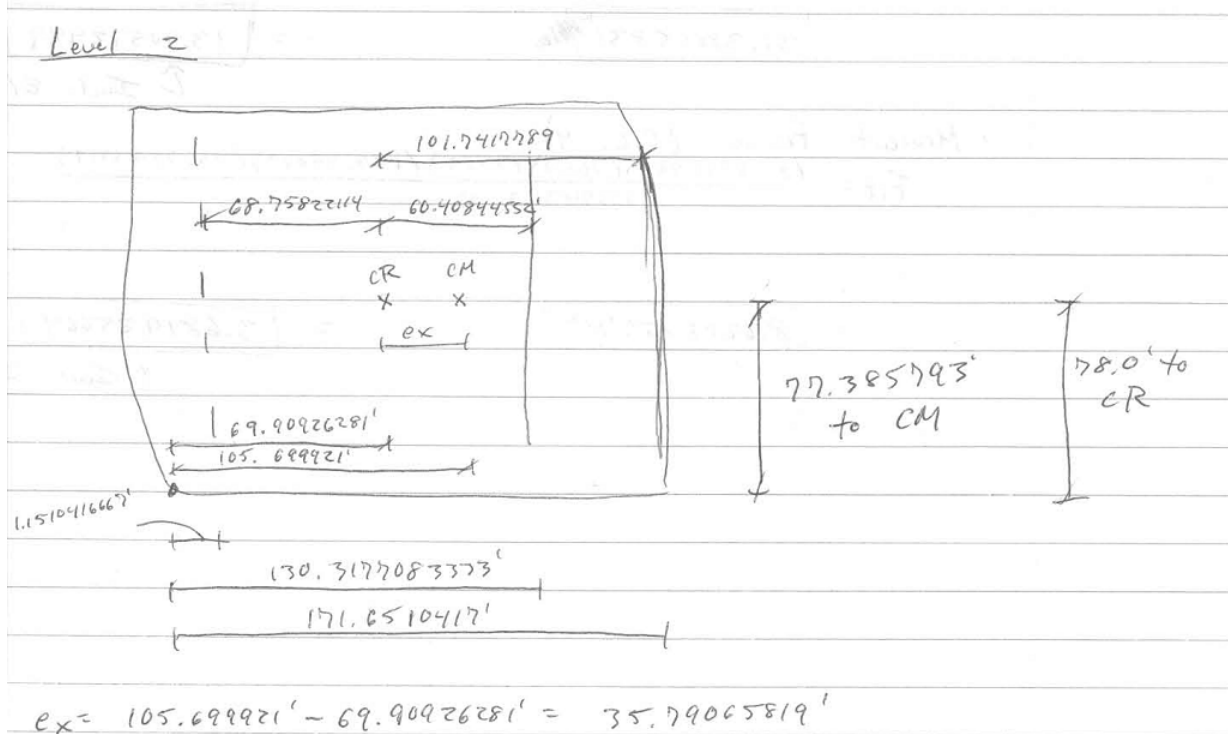

$$e_x = 105.6999' - 69.9093' = 35.7907'$$

$$P_y = 35.9602 \text{ k} + 69.0064 \text{ k} + 49.3738 \text{ k} = 154.3404 \text{ k}$$

$$\sum k_j d_j^2 = [(5)(29.3738)(68.7582)^2 + (21.3876)(101.7418')^2 + (2)(207.8138)(30')^2 + (2)(207.8138)(60')^2] = 3264647.291$$

Braced Frame (column line 1):

$$\text{Fit} = (29.3738 \text{ k/in})(68.7582')(154.3404 \text{ k})(35.7906') / 3264647.291 = 3.4174 \text{ k}$$

Braced Frame (column line 2):

$$\text{Fit} = (131.1475 \text{ k/in})(60.4084')(154.340 \text{ k})(35.7907') / 3264647.291 = 13.4051 \text{ k}$$

Moment Frame (column line 4):

$$\text{Fit} = (21.3876 \text{ k/in})(101.7418')(154.3404 \text{ k})(35.7907') / 3264647.291 = 3.6819 \text{ k}$$

Level 3: Seismic Load (unfactored)

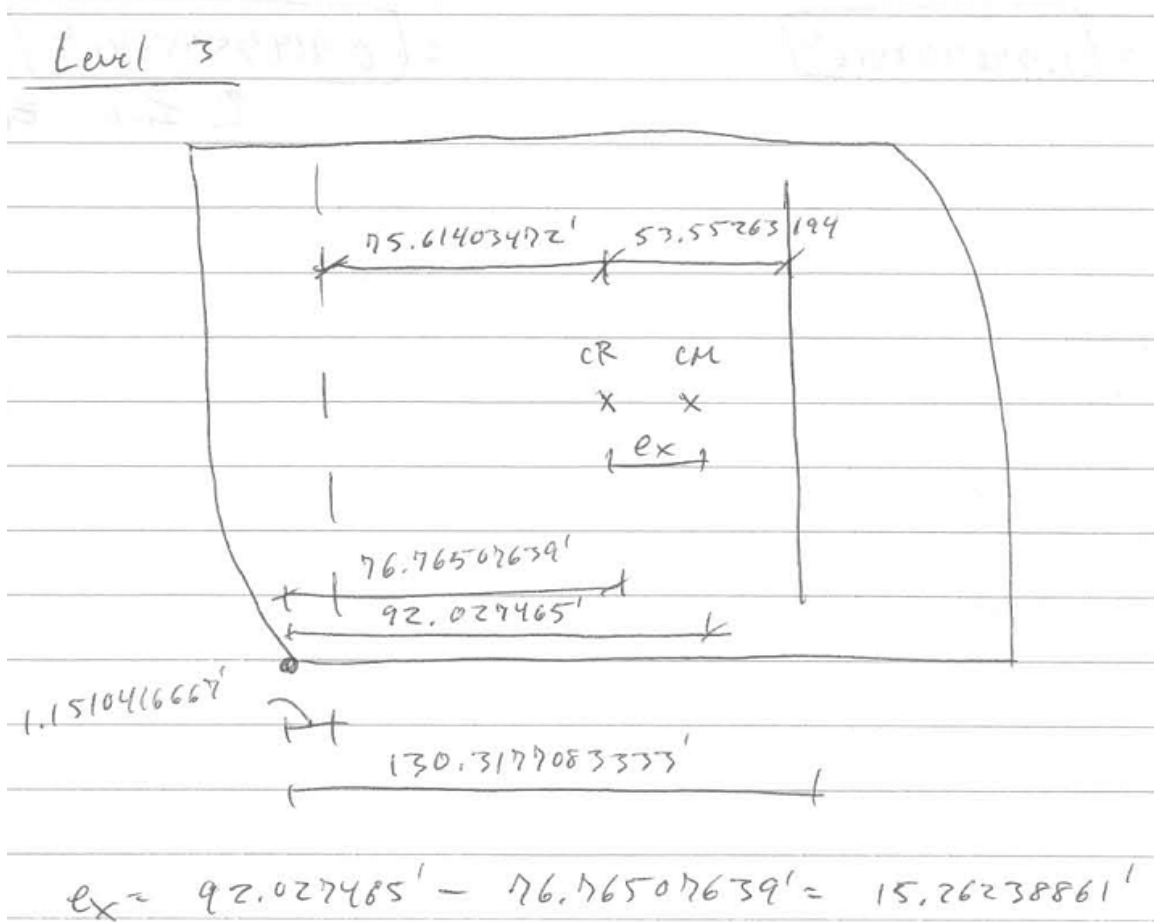

$$e_x = 92.0275' - 76.7651' = 15.2624'$$

$$P_y = 15.2063 \text{ k}$$

$$\sum k_j d_j^2 = [(5)(14.2331)(75.6140')^2 + (100.4823)(53.5526')^2 + (2)(74.4657)(30')^2 + (2)(74.4657)(60')^2] = 1365249.15$$

Braced Frame (column line 1) :

$$\text{Fit} = (14.2331 \text{ k/in})(75.6140')(15.2063 \text{ k})(15.2624')/1365249.15 = 0.1830 \text{ k}$$

Braced Frame (column line 2) :

$$\text{Fit} = (100.4823 \text{ k/in})(53.5526')(15.2063 \text{ k})(15.2624')/1365249.15 = 0.9148 \text{ k}$$

Level 4 : Seismic Load (unfactored)

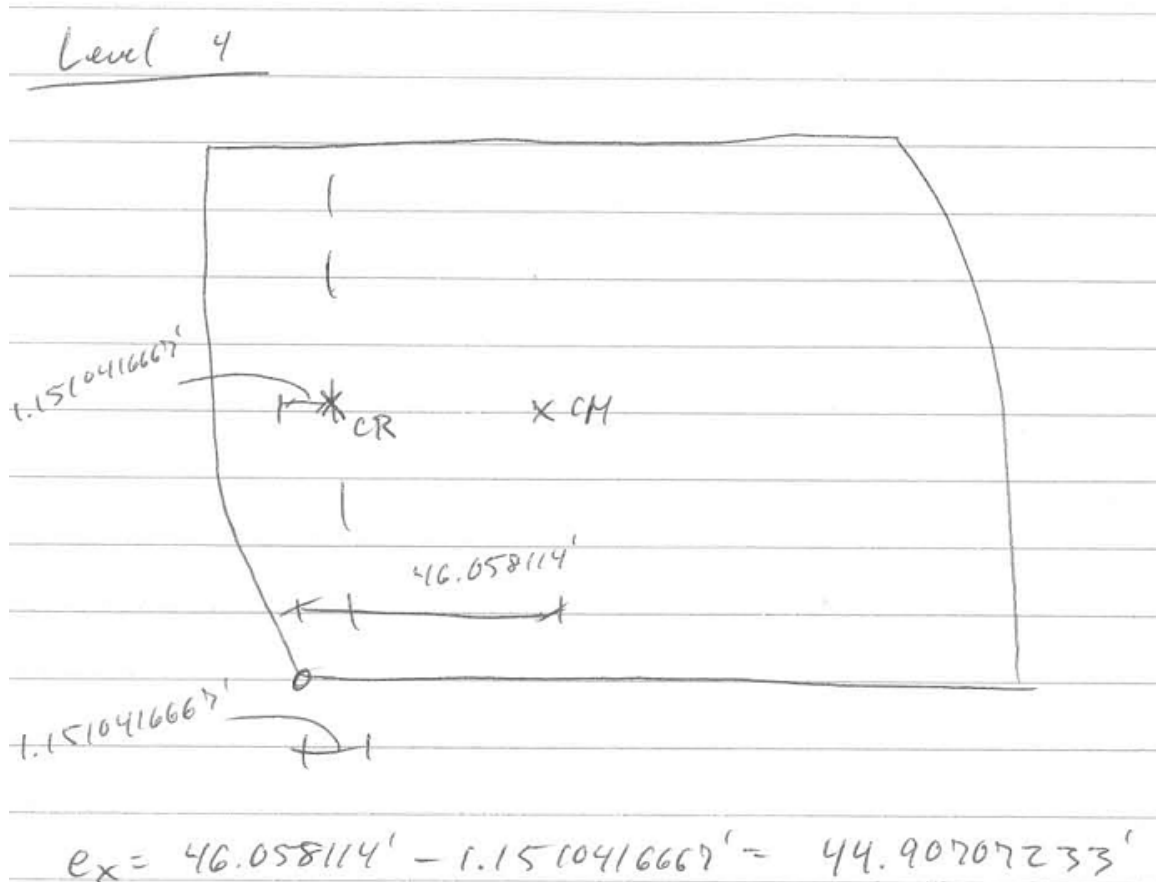

$$e_x = 46.0581' - 1.1510' = 44.9071'$$

$$P_y = 6.7972 \text{ k}$$

$$\sum k_j d_j^2 = [(6.6924)(0')^2] = 0$$

Braced Frame (column line 1) :

$$Fit = (6.6924 \text{ k/in})(0')(6.7972 \text{ k})(44.9071') / [(6.6924)(0')^2] = 0 \text{ k}$$

Level 1: Wind Load (unfactored) – Load Case 1

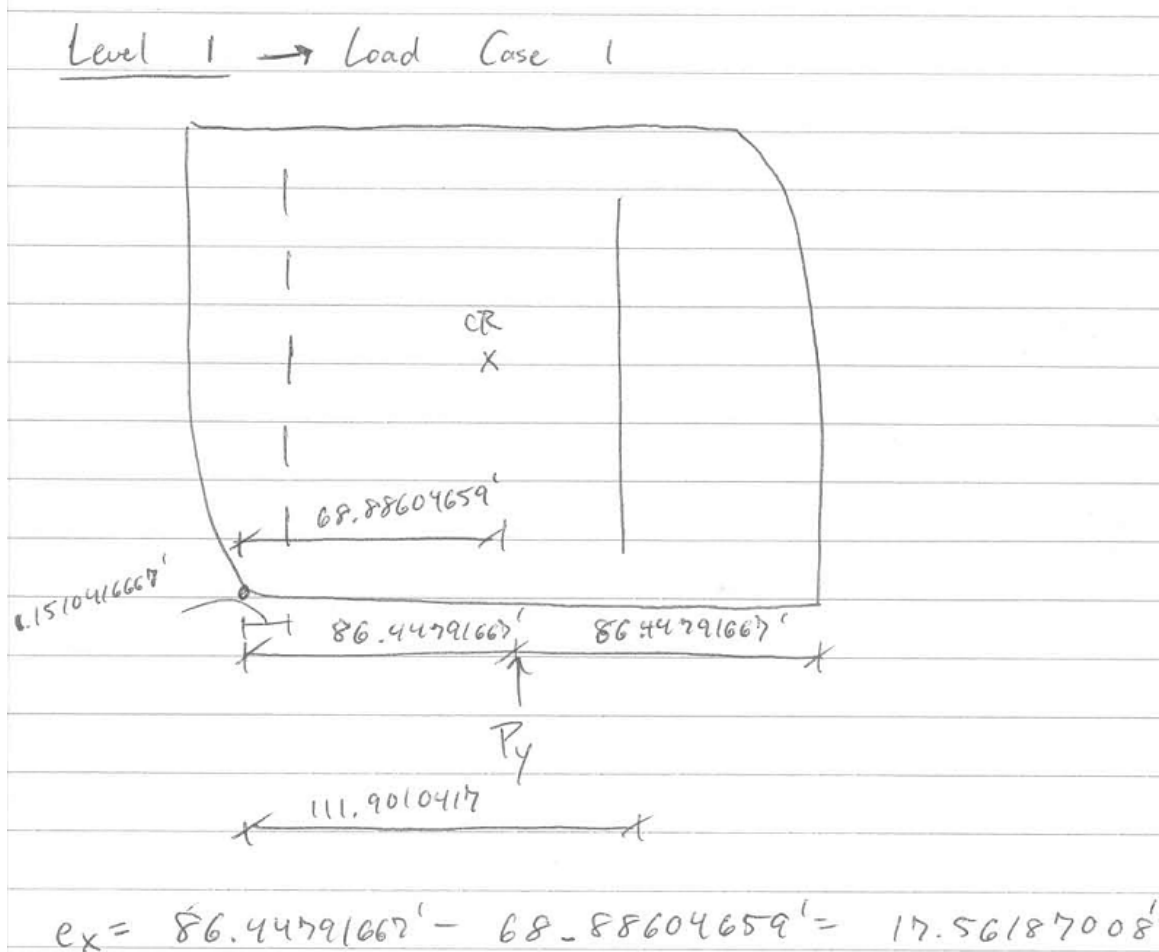

$$e_x = 86.4479' - 68.8860' = 17.5619'$$

$$P_y = [(955.5000 \text{ SF})(22.6903 \text{ PSF}) + (1289.1667 \text{ SF})(23.9899 \text{ PSF})]/1000 = 52.5962 \text{ k}$$

$$\sum k_j d_j^2 = [(5)(89.3176)(67.7350')^2 + (703.2349)(43.0150')^2 + (2)(391.3894)(30')^2 + (2)(391.3894)(60')^2] = 6872653.015$$

Braced Frame (column line 1):

$$\text{Fit} = (89.3176 \text{ k/in})(67.7350')(52.5962 \text{ k})(17.5619') / 6872653.015 = 0.8131 \text{ k}$$

Moment Frame (column line 1.8):

$$\text{Fit} = (703.2349 \text{ k/in})(43.0150')(52.5962 \text{ k})(17.5619') / 6872653.015 = 4.0656 \text{ k}$$

Level 2: Wind Load (unfactored) – Load Case 1

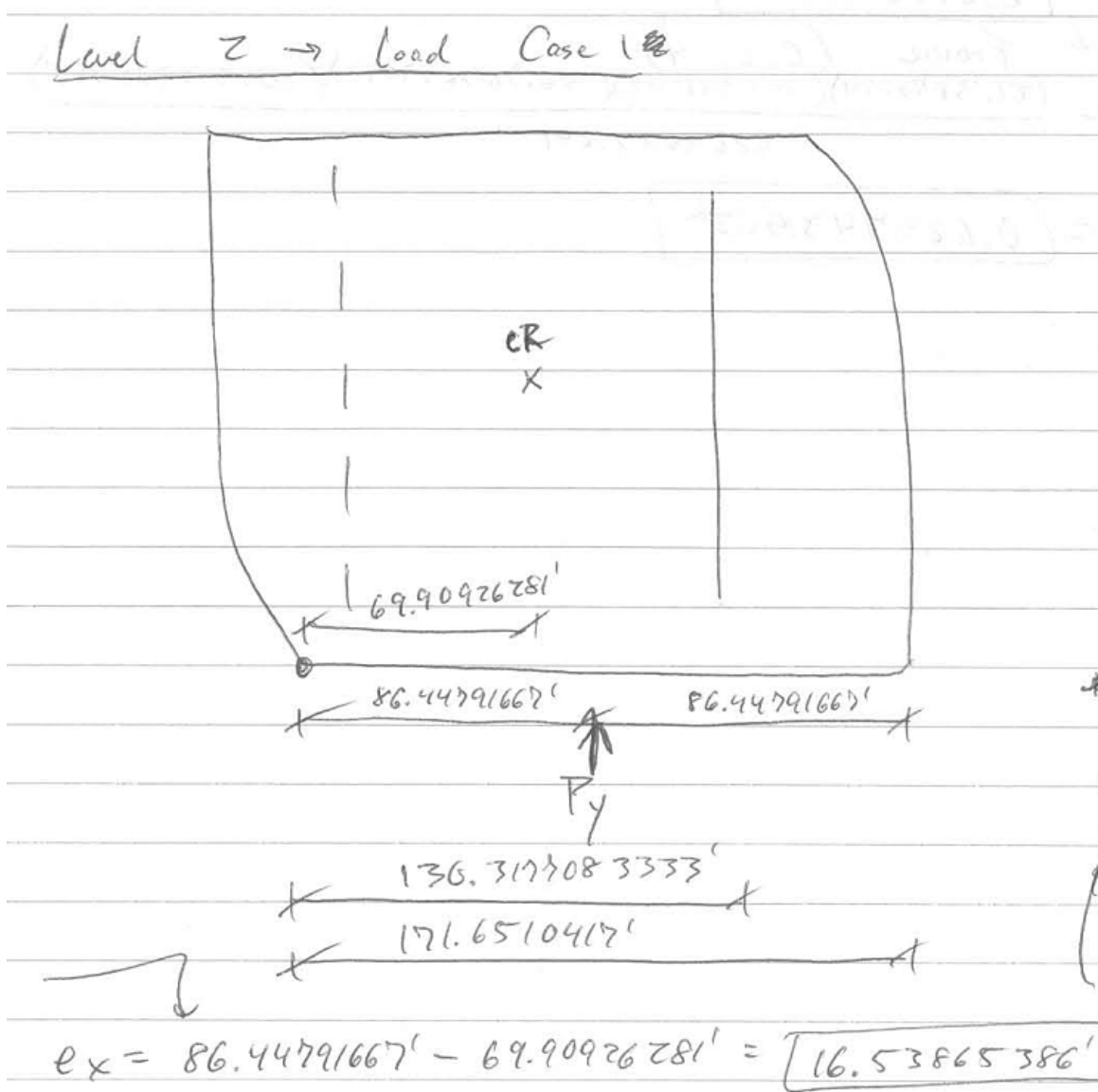

$$e_x = 86.4479' - 69.9093' = 16.5387'$$

$$P_y = [(1289.1667 \text{ SF})(23.9899 \text{ PSF}) + (1020.8421 \text{ SF})(25.3092 \text{ PSF})]/1000 = 56.7637 \text{ k}$$

$$\sum k_j d_j^2 = [(5)(29.3738)(68.7582)^2 + (21.3876)(101.7418')^2 + (2)(207.8138)(30')^2 + (2)(207.8138)(60')^2] = 3264647.291$$

Braced Frame (column line 1):

$$\text{Fit} = (29.3738 \text{ k/in})(68.7582')(56.7637 \text{ k})(16.5387')/3264647.291 = 0.5808 \text{ k}$$

Braced Frame (column line 2):

$$\text{Fit} = (131.1475 \text{ k/in})(60.4084')(56.7637 \text{ k})(16.5387')/3264647.291 = 2.2782 \text{ k}$$

Moment Frame (column line 4):

$$\text{Fit} = (21.3876 \text{ k/in})(101.7418')(56.7637 \text{ k})(16.5387')/3264647.291 = 0.6257 \text{ k}$$

Level 3: Wind Load (unfactored) – Load Case 1

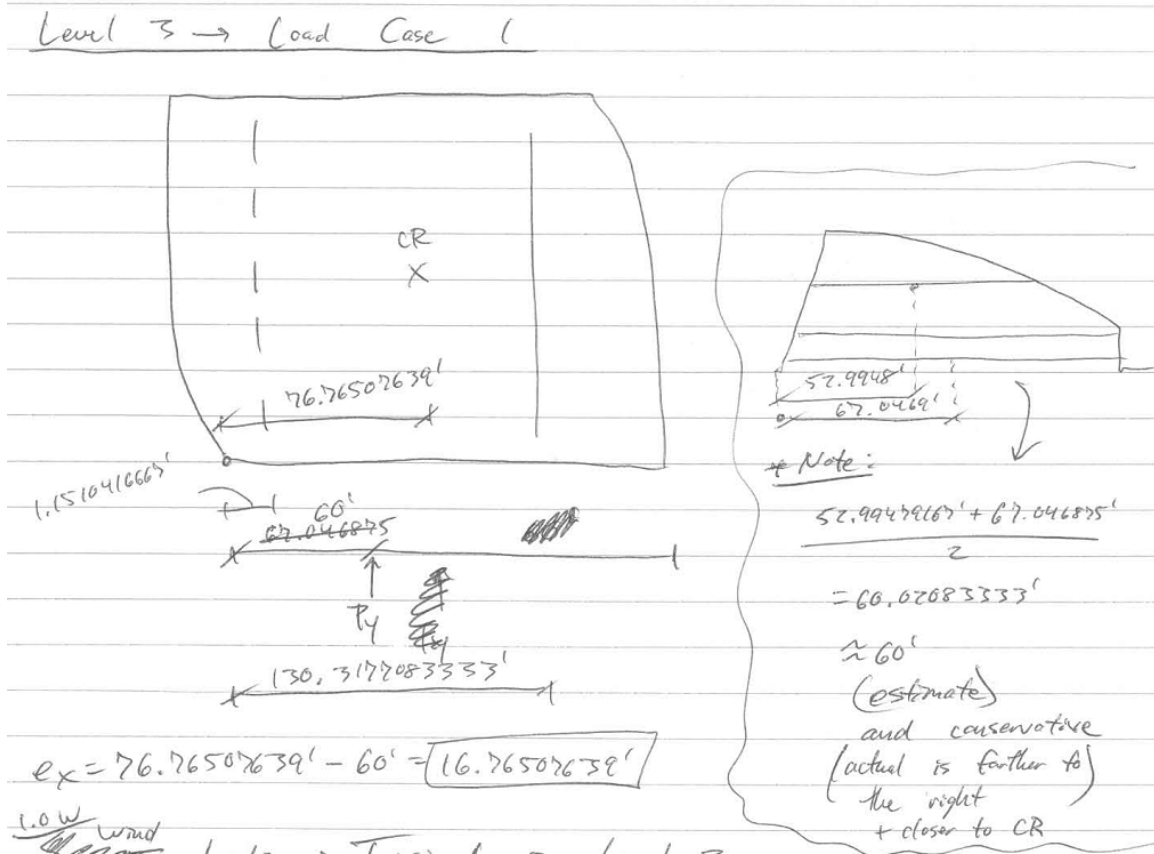

$$e_x = 76.7651' - 60' = 16.7651'$$

$$P_y = [(847.2241 \text{ SF})(25.3092 \text{ PSF}) + (907.8754 \text{ SF})(26.4401 \text{ PSF})]/1000 = 45.4469 \text{ k}$$

$$\sum k_j d_j^2 = [(5)(14.2331)(75.6140)^2 + (100.4823)(53.5526')^2 + (2)(74.4657)(30')^2 + (2)(74.4657)(60')^2] = 1365249.15$$

Braced Frame (column line 1) :

$$\text{Fit} = (14.2331 \text{ k/in})(75.6140')(45.4469 \text{ k})(16.7651')/1365249.15 = 0.6006 \text{ k}$$

Braced Frame (column line 2) :

$$\text{Fit} = (100.4823 \text{ k/in})(53.5526')(45.4469 \text{ k})(16.7651')/1365249.15 = 3.0031 \text{ k}$$

Level 4 : Wind Load (unfactored) – Load Case 1

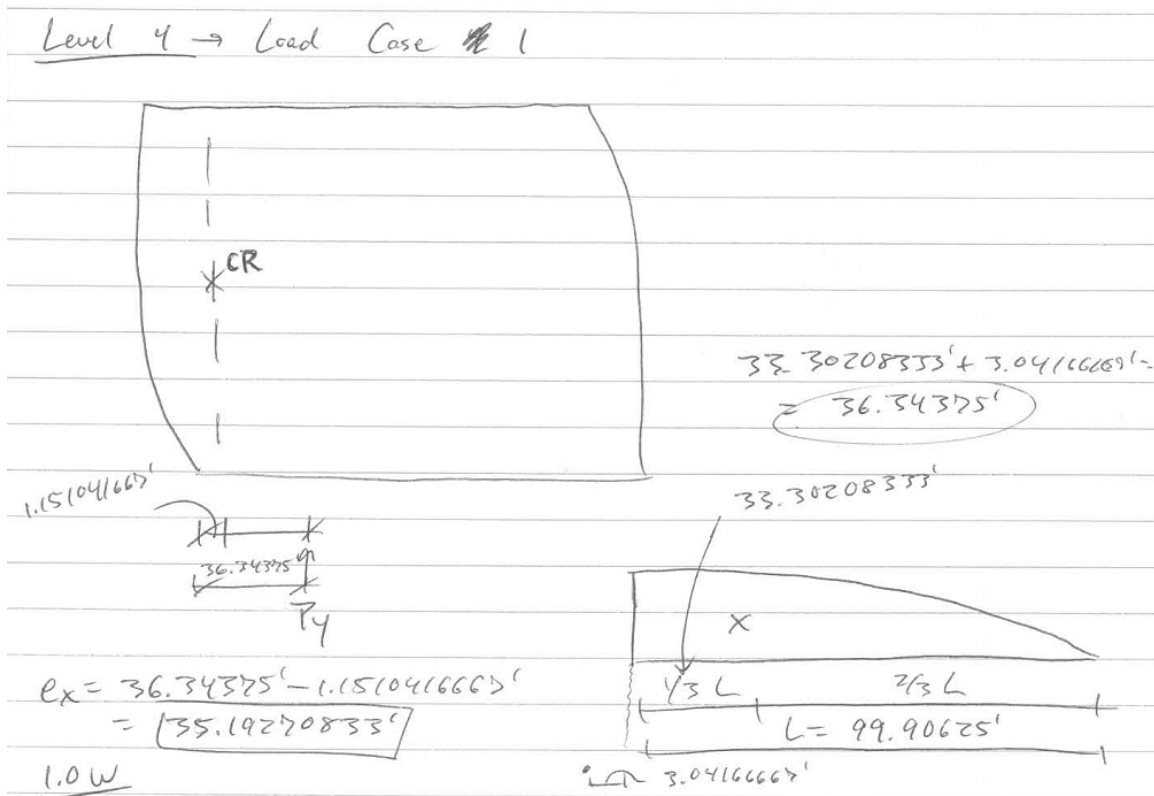

$$e_x = 36.3438' - 1.1510' = 35.1927'$$

$$P_y = (530.7316 \text{ SF})(26.4401 \text{ PSF})/1000 = 14.0325 \text{ k}$$

$$\sum k_j d_j^2 = [(6.6924)(0')^2] = 0$$

Braced Frame (column line 1) :

$$\text{Fit} = (6.6924 \text{ k/in})(0')(14.0325 \text{ k})(35.1927') / [(6.6924)(0')^2] = 0 \text{ k}$$

Load Case 2: Multiply loads by 0.75 and use an extra eccentricity of 0.15b_x

Level 1: Wind Load (unfactored) – Load Case 2

$$e_x = 17.5619' + (0.15)(172.8958') = 43.4962'$$

$$P_y = (0.75)(52.5962 \text{ k}) = 39.4472$$

$$\sum k_j d_j^2 = [(5)(89.3176)(67.7350')^2 + (703.2349)(43.0150')^2 + (2)(391.3894)(30')^2 + (2)(391.3894)(60')^2] = 6872653.015$$

Braced Frame (column line 1):

$$\text{Fit} = (89.3176 \text{ k/in})(67.7350')(39.4472 \text{ k})(43.4962') / 6872653.015 = 1.5104 \text{ k}$$

Moment Frame (column line 1.8):

$$\text{Fit} = (703.2349 \text{ k/in})(43.0150')(39.4472 \text{ k})(43.4962') / 6872653.015 = 7.5520 \text{ k}$$

Level 2: Wind Load (unfactored) – Load Case 2

$$e_x = 16.5387' + (0.15)(172.8958') = 42.4730'$$

$$P_y = (0.75)(56.7637 \text{ k}) = 42.5728 \text{ k}$$

$$\sum k_j d_j^2 = [(5)(29.3738)(68.7582')^2 + (21.3876)(101.7418')^2 + (2)(207.8138)(30')^2 + (2)(207.8138)(60')^2] = 3264647.291$$

Braced Frame (column line 1):

$$\text{Fit} = (29.3738 \text{ k/in})(68.7582')(42.5728 \text{ k})(42.4730') / 3264647.291 = 1.1186 \text{ k}$$

Braced Frame (column line 2):

$$\text{Fit} = (131.1475 \text{ k/in})(60.4084')(42.5728 \text{ k})(42.4730') / 3264647.291 = 4.3880 \text{ k}$$

Moment Frame (column line 4):

$$\text{Fit} = (21.3876 \text{ k/in})(101.7418')(42.5728 \text{ k})(42.4730') / 3264647.291 = 1.2052 \text{ k}$$

Level 3: Wind Load (unfactored) – Load Case 2

$$e_x = 16.7651' + (0.15)((2)(60.0208')) = 34.7713'$$

$$P_y = (0.75)(45.4469 \text{ k}) = 34.0852 \text{ k}$$

$$\sum k_j d_j^2 = [(5)(14.2331)(75.6140')^2 + (100.4823)(53.5526')^2 + (2)(74.4657)(30')^2 + (2)(74.4657)(60')^2] = 1365249.15$$

Braced Frame (column line 1) :

$$\text{Fit} = (14.2331 \text{ k/in})(75.6140')(34.7713 \text{ k})(34.0852') / 1365249.15 = 0.9343 \text{ k}$$

Braced Frame (column line 2) :

$$\text{Fit} = (100.4823 \text{ k/in})(53.5526') (34.7713 \text{ k})(34.0852') / 1365249.15 = 4.6714 \text{ k}$$

Level 4: Wind Load (unfactored) – Load Case 2

$$e_x = 35.1927' + (0.15)((2)(36.3438')) = 46.0958'$$

$$P_y = (0.75)(14.0325 \text{ k}) = 10.5244 \text{ k}$$

$$\sum k_j d_j^2 = [(6.6924)(0')^2] = 0$$

Braced Frame (column line 1) :

$$\text{Fit} = (6.6924 \text{ k/in})(0')(10.5244 \text{ k})(46.0958') / [(6.6924)(0')^2] = 0 \text{ k}$$

East/West Direction:

Torsional effects were not accounted for in the East/West direction since the center of mass and center of rigidity either matched up perfectly in the y-direction for each floor or was only off by less than one foot. Load Case 2 was not considered for the East/West direction either because it was assumed that any small torsional effects would not control in this direction. The five frames in the East/West direction are center on the building and are evenly spaced at 30'-0" apart each, so torsional effects should be minimal in this direction.