



**An Experimental Enquiry concerning the Natural Powers of Water and
Wind to Turn Mills, and Other Machines, Depending on a Circular Motion.
By Mr. J. Smeaton, F. R. S.**

J. Smeaton

Philosophical Transactions (1683-1775), Vol. 51 (1759 - 1760), 100-174.

Stable URL:

<http://links.jstor.org/sici?sici=0260-7085%281759%2F1760%2951%3C100%3AAAEECTN%3E2.0.CO%3B2-X>

Philosophical Transactions (1683-1775) is currently published by The Royal Society.

Your use of the JSTOR archive indicates your acceptance of JSTOR's Terms and Conditions of Use, available at <http://www.jstor.org/about/terms.html>. JSTOR's Terms and Conditions of Use provides, in part, that unless you have obtained prior permission, you may not download an entire issue of a journal or multiple copies of articles, and you may use content in the JSTOR archive only for your personal, non-commercial use.

Please contact the publisher regarding any further use of this work. Publisher contact information may be obtained at <http://www.jstor.org/journals/rsl.html>.

Each copy of any part of a JSTOR transmission must contain the same copyright notice that appears on the screen or printed page of such transmission.

JSTOR is an independent not-for-profit organization dedicated to creating and preserving a digital archive of scholarly journals. For more information regarding JSTOR, please contact support@jstor.org.

- 1845 *Trillium flore pedunculato cernuo*, Lin. Sp. Pl. 339.
- 1846 *Valeriana montana subrotundo folio*, C. B. P. 165.
- 1847 *Vicia pedunculis multifloris*, petiolis polyphillis, foliolis lanceolatis glabris, Hort. Upsal, 219.
- 1848 *Vicia sylvatica multiflora maxima perennis*, tetro odore, floribus albetibus, lineis cæruleis striatis, Pluk. Alm. 387.
- 1849 *Vinca foliis oblongo-ovatis integerrimis*, tubo floris longissimo, caule ramoso fruticoso, Miller's Iconf.
- 1850 *Xanthium*, five *Lappa minor*, J. B. 3. 572.
Lappa minor, five *Xanthium Dioscorid.* C. B. P. 198.
-

XVIII. *An experimental Enquiry concerning the natural Powers of Water and Wind to turn Mills, and other Machines, depending on a circular Motion.* By Mr. J. Smeaton, F. R. S.

Read May 3, & 10, 1759. **W**HAT I have to communicate on this subject was originally deduced from experiments made on working models, which I look upon as the best means of obtaining the outlines in mechanical enquiries. But in this case it is very necessary to distinguish the circumstances in which a model differs from a machine in large; otherwise a model is more apt to lead us from the truth

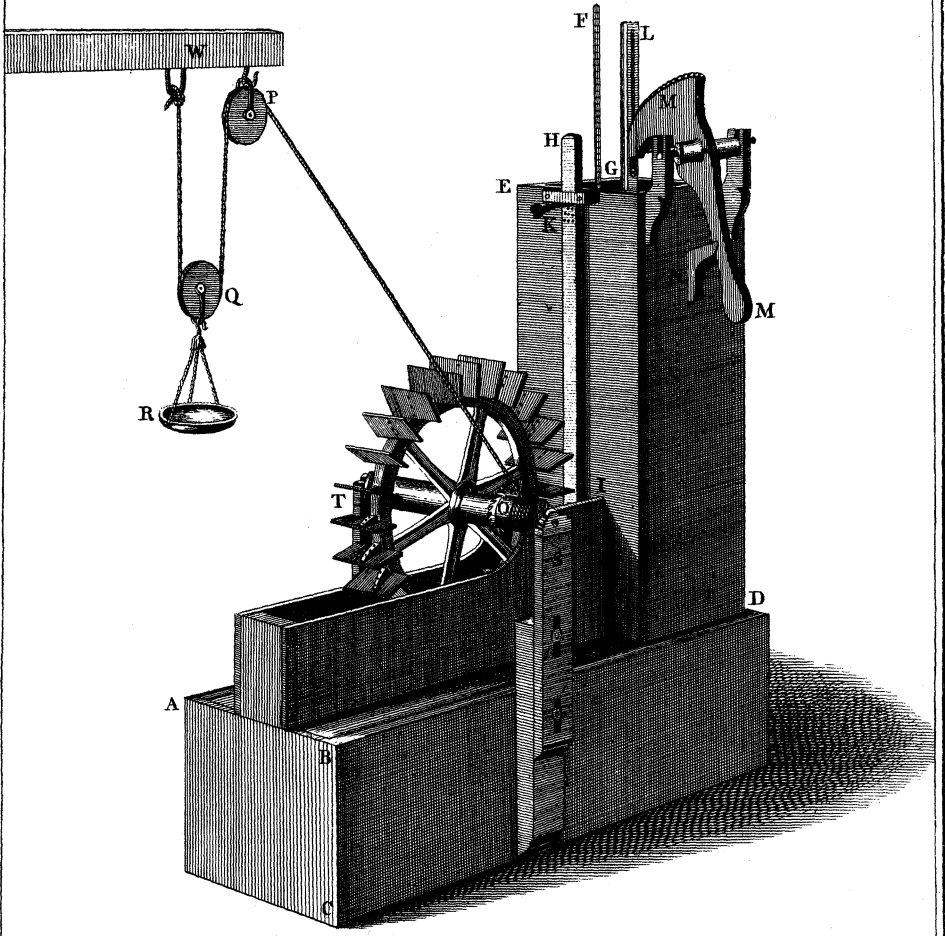

J. Smaton delin.

J. Mynde sc.

truth than towards it. Hence the common observation, that a thing may do very well in a model, that will not answer in large. And indeed, tho' the utmost circumspection be used in this way, the best structure of machines cannot be fully ascertained, but by making trials with them, when made of their proper size. It is for this reason, that, tho' the models referred to, and the greatest part of the following experiments, were made in the years 1752 and 1753, yet I deferred offering them to the Society, till I had an opportunity of putting the deductions made therefrom in real practice, in a variety of cases, and for various purposes; so as to be able to assure the Society, that I have found them to answer.

P A R T I.

Concerning UNDERSHOT WATER-WHEELS.

PLATE IV. Fig. I. is a perspective view of the machine for experiments on water-wheels; wherein ABCD is the lower cistern, or magazine, for receiving the water, after it has quitted the wheel; and for supplying
 DE the upper cistern, or head; wherein the water being raised to any height required, by a pump, that height is shewn by
 F G, a small rod, divided into inches and parts; with a float at the bottom, to move the rod up and down, as the surface of the water rises and falls.
 HI is a rod by which the sluice is drawn, and stopt at any height required, by means of
 K a pin or peg, which fits several holes, placed

in the manner of a diagonal scale, upon the face of the rod H I.

G L is the upper part of the rod of the pump, for drawing the water out of the lower cistern, in order to raise and keep up the surface thereof at its desired height, in the head D E ; thereby to supply the water, expended by the aperture of the sluice.

M M is the arch and handle for working the pump, which is limited in its stroke by

N a piece for stopping the handle from raising the piston too high ; that also being prevented from going too low, by meeting the bottom of the barrel.

O is the cylinder, upon which a cord winds, and which being conducted over the pullies P and Q, raises

R, the scale, into which the weights are put, for trying the power of the water.

S T the two standards, which support the wheel, are made to slide up and down, in order to adjust the wheel, as near as possible, to the floor of the conduit.

W the beam which supports the scale and pulleys ; this is represented as but little higher than the machine, for the sake of bringing the figure into a moderate compass, but in reality is placed 15 or 16 feet higher than the wheel.

PLATE V. Fig. 2. is a section of the same machine, wherein the same parts are marked with the same letters as in Fig. 1. Besides which

X X is the pump barrel, being 5 inches diameter, and 11 inches long.

Y is

Scale of Inches to fig. 3.

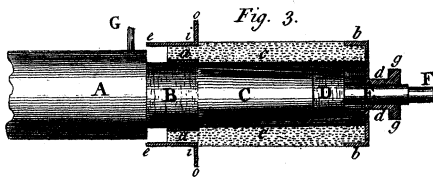
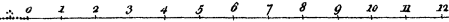
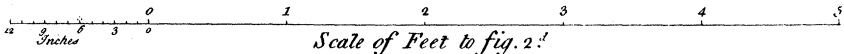
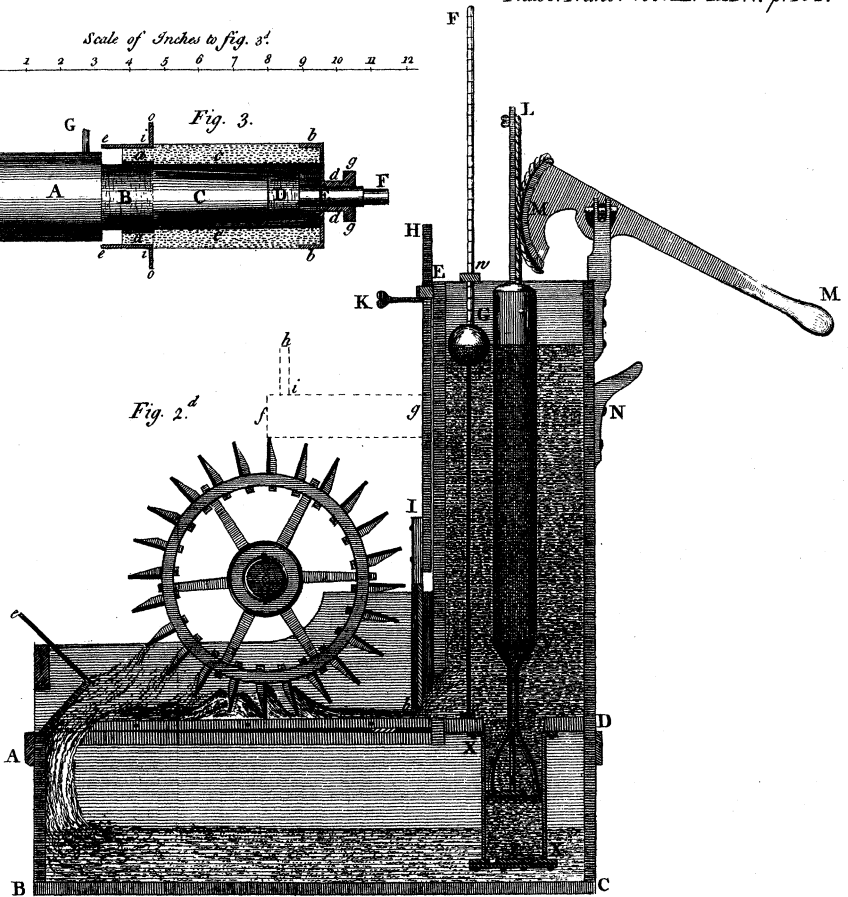

Fig. 2.



Y is the piston ; and

Z the fixed valve.

G V is a cylinder of wood, fixed upon the pump-rod, and reaches above the surface of the water ; this piece of wood being of such a thickness, that its section is half the area of that of the pump-barrel, will cause the surface of water to rise in the head, as much while the piston is descending, as while it is rising : and will thereby keep the gauge-rod F G more equally to its height. *Note*, the arch and handle M M is here represented on a different side to what it is shewn in the preceding figures, in order that its dimensions may the better appear.

a a shews one of the two wires which serve as directors to the float, in order that the gauge rod F G may be kept perpendicular ; for the same purpose also serves *w*, a piece of wood with a hole to receive the gauge-rod, and keep it upright.

b is the aperture of the sluice.

c c a kant-board, for throwing the water more directly down the opening *c d*, into the lower cistern : and

c e is a sloping board, for bringing back the water that is thrown up by the floats of the wheel.

Fig. 3. represents one end of the main axis, with a section of the moveable cylinder, marked O in the preceding figures.

A B C D is the end of the axis ; whereof the parts B and D are covered with ferrules or hoops of brass.

E is a cylinder of metal ; whereof the part marked

F is

F is the pivot or gudgeon.

cc is the section of an hollow cylinder of wood, the diameter of the interior part being somewhat larger than the cylindrical ferrule B.

aa is the section of a ferrule of brass, driven into the end of the hollow cylinder, and which is adjusted to that marked B, so as to slide freely thereupon, but with as little shake as possible.

bb, dd, gg, represent the section of a brass ferrule, plate, and socket, fixed upon the other end of the hollow cylinder; the socket *dd* being adjusted to slide freely upon the cylinder E, in the same manner as the ferrule *aa* slides upon the cylinder B: the outer end of the socket at

gg is formed into a sort of button; by pushing whereof, the hollow cylinder will move backwards and forwards, or turn round at pleasure upon the cylindrical parts of the axis B and E.

ee, ii, oo, represent the section of a brass ferrule, also fixed upon the hollow cylinder: the edge of this ferrule

ee is cut into teeth, in the manner of a *contrate* wheel; and the edge thereof

oo is cut in the manner of a ratchett.

Of consequence, when the plate *bddb* is pushed close to the ferrule D, the teeth of the ferrule *ee* will lay hold of

G, a pin fixed into the axis; by which means the hollow cylinder is made to turn along with the wheel and axis: but being drawn back by the button *gg*, the hollow cylinder is thereby disengaged from the pin G, and ceases turning.

Note. The weight in the scale is prevented from

from running back, by a catch that plays in and lays hold of the ratchet *oo*.

By this means the hollow cylinder upon which the cord winds, and raises the weight, is put in action and discharged therefrom instantaneously, while the wheel is in motion: for without some contrivance of this kind, it would not be easy to make this sort of experiments with any tolerable degree of exactness.

The use of the apparatus now described will be rendered more intelligible, by giving a general idea of what I had in view; but as I shall be obliged to make use of a term which has heretofore been the cause of disputation, I think it necessary to assign the sense in which I would be understood to use it; and in which I apprehend it is used by practical *Mechanicks*.

The word *Power*, as used in practical mechanicks, I apprehend to signify the exertion of strength, gravitation, impulse, or pressure, so as to produce motion: and by means of strength, gravitation, impulse, or pressure, compounded with motion, to be capable of producing an effect: and that no effect is properly mechanical, but what requires such a kind of power to produce it.

The raising of a weight, relative to the height to which it can be raised in a given time, is the most proper measure of power; or, in other words, if the weight raised is multiplied by the height to which it can be raised in a given time, the product is the measure of the power raising it; and consequently, all those powers are equal, whose products, made by

such multiplication, are equal: for if a power can raise twice the weight to the same height; or the same weight to twice the height, in the same time that another power can, the first power is double the second: and if a power can raise half the weight to double the height; or double the weight to half the height, in the same time that another can, those two powers are equal. But note, all this is to be understood in case of slow or equable motion of the body raised; for in quick, accelerated, or retarded motions, the *vis inertiae* of the matter moved will make a variation.

In comparing the effects produced by water-wheels, with the powers producing them; or, in other words, to know what part of the original power is necessarily lost in the application, we must previously know how much of the power is spent in overcoming the friction of the machinery, and the resistance of the air; also what is the real velocity of the water at the instant that it strikes the wheel; and the real quantity of water expended in a given time.

From the velocity of the water, at the instant that it strikes the wheel, given; the height of head productive of such velocity can be deduced, from acknowledged and experimented principles of hydrostatics: so that by multiplying the quantity, or weight of water, really expended in a given time, by the height of head so obtained; which must be considered as the height from which that weight of water had descended in that given time; we shall have a product, equal to the original power of the water; and clear of all uncertainty, that would arise from the friction of the water, in passing small apertures;
and

and from all doubts, arising from the different measure of spouting waters, assigned by different authors. On the other hand, the sum of the weights raised by the action of this water, and of the weight required to overcome the friction and resistance of the machine, multiplied by the height to which the weight can be raised in the time given, the product will be equal to the effect of that power; and the proportion of the two products will be the proportion of the *power* to the *effect*: so that by loading the wheel with different weights successively, we shall be able to determine at what particular load, and velocity of the wheel, the effect is a *maximum*.

The manner of finding the real velocity of the water, at the instant of its striking the wheel; the manner of finding the value of the friction, resistance, &c. in any given case; and the manner of finding the real expence of water, so far as concerns the following experiments, without having recourse to theory; being matters upon which the following determinations depend, it will be necessary to explain them.

To determine the Velocity of the Water striking the Wheel.

It has already been mentioned, in the references to the figures, that weights are raised by a cord winding round a cylindrical part of the axis. First, then, let the wheel be put in motion by the water, but without any weights in the scale; and let the number of turns in a minute be 60: now it is evident, that was the wheel free from friction and resistance, that 60 times the circumference of the wheel

would be the space through which the water would have moved in a minute; with that velocity where-with it struck the wheel: but the wheel being incumbered by friction and resistance, and yet moving 60 turns in a minute, it is plain, that the velocity of the water must have been greater than 60 circumferences before it met with the wheel. Let now the cord be wound round the cylinder, but contrary to the usual way, and put a weight in the scale; the weight so disposed (which may be called the *counter-weight*) will endeavour to assist the wheel in turning the same way, as it would have been turned by the water: put therefore as much weight into the scale as, without any water, will cause it to turn somewhat faster than at the rate of 60 turns in a minute; suppose 63: let it now be tried again by the water, assisted by the weight; the wheel therefore will now make more than 60 turns; suppose 64: hence we conclude the water still exerts some power in giving motion to the wheel. Let the weight be again increased, so as to make $64\frac{1}{2}$ turns in a minute without water: let it once more be tried with water as before; and suppose it now to make the same number of turns with water as without. *viz.* $64\frac{1}{2}$: hence it is evident, that in this case the wheel makes the same number of turns in a minute, as it would do if the wheel had no friction or resistance at all; because the weight is equivalent thereto; for was it too little, the water would accelerate the wheel beyond the weight; and if too great, retard it; so that the water now becomes a *regulator* of the wheel's motion; and the velocity of its circumference becomes a measure of the velocity of the water.

In

In like manner, in seeking the greatest product, or *maximum* of effect; having found by trials what weight gives the greatest product, by simply multiplying the weight in the scale by the number of turns of the wheel, find what weight in the scale, when the cord is on the contrary side of the cylinder, will cause the wheel to make the same number of turns the same way, without water; it is evident that this weight will be nearly equal to all friction and resistance taken together; and consequently, that the weight *in* the scale, with twice * the weight of the scale, added to the back or counter-weight, will be equal to the weight that could have been raised, supposing the machine had been without friction or resistance; and which multiplied by the height to which it was raised, the product will be the greatest effect of that power.

The quantity of water expended is found thus :

The pump made use of for replenishing the head with water was so carefully made, that no water escaping back by the leathers, it delivered the same quantity of water at every stroke, whether worked quick or slow; and as the length of the stroke was limited, consequently the value of one stroke (or on account of more exactness 12 strokes) was known, by the height to which the water was thereby raised in the head; which being of a regular figure was easily measured. The sluice, by which the water was drawn upon the wheel, was made to stop at certain heights by a peg; so that when the peg was in the same hole,

* The weight of the scale makes part of the weight both ways.

the aperture for the effluent water was the same. Hence the quantity of water expended by any given head, and opening of the sluice, may be obtained: for by observing how many strokes a minute was sufficient to keep up the surface of the water at the given height, and multiplying the number of strokes by the value of each, the water expended by any given aperture and head in a given time will be given.

These things will be further illustrated by going over the *calculus* of one set of experiments.

Specimen of a Set of Experiments.

The sluice drawn to the 1ft hole.

The water above the floor of the sluice	30	Inches.
Strokes of the pump in a minute	— 39½	
The head raised by 12 strokes	— 21	Inches.
The wheel raised the empty scale, and made turns in a minute	— — — — —	80
With a counter-weight of 1 lb. 8 oz. it made		85
D° tried with water	— — — — —	86

N°	Weight. <i>lb. oz.</i>	Turns in a min.	Product.
1 —	4 0	— 45 —	180
2 —	5 0	— 42 —	210
3 —	6 0	— 36¼ —	217¼
4 —	7 0	— 33¾ —	236¾
5 —	8 0	— 30 —	240 maximum.
6 —	9 0	— 26½ —	238½
7 —	10 0	— 22 —	220
8 —	11 0	— 16¾ —	181¾
9 —	12	* ceased working.	

* *N. B.* When the wheel moves so slow as not to rid the water so fast as supplied by the sluice, the accumulated water falls back upon the aperture, and the wheel immediately ceases moving.

Counter-weight, for 30 turns without water, 2 oz. in the scale.

N. B. The area of the head was 105,8 square inches.

Weight of the empty scale and pulley, 10 oz.

Circumference of the cylinder, 9 inches.

Circumference of the water-wheel, 75 ditto.

Reduction of the above Set of Experiments.

The circumference of the wheel, 75 inches, multiplied by 86 turns, gives 6450 inches for the velocity of the water in a minute; $\frac{1}{60}$ of which will be the velocity in a second, equal to 107,5 inches, or 8,96 feet, which is due to a head of 15 inches*; and this we call the *virtual* or *effective* head.

The area of the head being 105,8 inches, this multiplied by the weight of water of the inch cubic, equal to the decimal ,579 of the ounce avoirdupoise, gives 61,26 ounces for the weight of as much water, as is contained in the head, upon 1 inch in depth, $\frac{1}{60}$ of which is 3,83 pounds; this multiplied by the depth 21 inches, gives 80,43 lb. for the value of 12 strokes; and by proportion, $39\frac{1}{2}$ (the number made in a minute) will give 264,7 lb. the weight of water expended in a minute.

Now as 264,7 lb. of water may be considered as having descended through a space of 15 inches in a minute, the product of these two numbers 3970 will express the *power* of the water to produce mechanical effects; which were as follows.

* This is determined upon the common maxim of hydrostatics, that the velocity of spouting waters is equal to the velocity that an heavy body would acquire in falling from the height of the reservoir; and is proved by the rising of jets to the height of their reservoirs nearly.

The velocity of the wheel at the *maximum*, as appears above, was 30 turns a minute; which multiplied by 9 inches, the circumference of the cylinder, makes 270 inches; but as the scale was hung by a pulley and double line, the weight was only raised half of this, *viz.* 135 inches.

The weight in the scale at the maximum 8 lb. 0 oz.

Weight of the scale and pulley — 0 10

Counterweight, scale, and pulley — 0 12

Sum of the resistance — — 9 6

or lb. 9,375.

Now as 9,375 lb. is raised 135 inches, these two numbers being multiplied together, the product is 1266, which expresses the effect produced at a maximum: so that the proportion of the *power* to the *effect* is as 3970 : 1266, or as 10 : 3,18.

But tho' this is the greatest *single* effect producible from the power mentioned, by the impulse of the water upon an undershot wheel; yet, as the whole power of the water is not exhausted thereby, this will not be the true ratio between the *power* of the water, and the *sum* of all the *effects* producible therefrom: for as the water must necessarily leave the wheel with a velocity equal to the wheel's circumference, it is plain that some part of the power of the water must remain after quitting the wheel.

The velocity of the wheel at the maximum is 30 turns a minute; and consequently its circumference moves at the rate of 3,123 feet a second, which answers to a head 1,82 inches; this being multiplied by the expence of water in a minute, *viz.* 264,7 lb. produces 481 for the power *remaining* in the water after it has passed the wheel: this being therefore deducted

deducted from the original power 3970, leaves 3489, which is that *part* of the power which is spent in producing the effect 1266; and consequently the part of the power spent in producing the effect, is to the greatest effect producible thereby as 3489 : 1266 :: 10 : 3,62, or as 11 to 4.

The *velocity of the water* striking the wheel has been determined to be equal to 86 circumferences of the wheel per minute, and the *velocity of the wheel* at the *maximum* to be 30; the velocity of the water will therefore be to that of the wheel as 86 to 30, or as 10 to 3,5, or as 20 to 7.

The *load at the maximum* has been shown to be equal to 9 lb. 6 oz. and that the wheel ceased moving with 12 lb. in the scale: to which if the weight of the scale is added, *viz.* 10 ounces *, the proportion will be nearly as 3 to 4 between the load at the *maximum* and *that* by which the wheel is stopped.

It is somewhat remarkable, that tho' the velocity of the wheel in relation to the water turns out greater than $\frac{1}{3}$ of the velocity of the the water, yet the impulse of the water in the case of a *maximum* is more than double of what is assigned by theory; that is, instead of $\frac{4}{9}$ of the column, it is nearly equal to the whole column.

It must be remembred, therefore, that, in the present case, the wheel was not placed in an open river, where the natural current, after it has communicated its impulse to the float, has room on all sides to escape, as the theory supposes; but in a conduit or

* The resistance of the air in this case ceases, and the friction is not added, as 12 lb. in the scale was sufficient to stop the wheel after it had been in full motion; and therefore somewhat more than a counterbalance to the impulse of the water.

race, to which the float being adapted, the water cannot otherwise escape than by moving along with the wheel. It is observable, that a wheel working in this manner, as soon as the water meets the float, receiving a sudden check, it rises up against the float, like a wave against a fixed object; insomuch that when the sheet of water is not a quarter of an inch thick before it meets the float, yet this sheet will act upon the whole surface of a float, whose height is 3 inches; and consequently was the float no higher than the thickness of the sheet of water, as the theory also supposes, a great part of the force would have been lost, by the water's dashing over the float*.

In further confirmation of what is already delivered, I have adjoined the following table, containing the result of 27 sets of experiments, made and reduced in the manner above specified. What remains of the theory of undershot wheels, will naturally follow from a comparison of the different experiments together.

* Since the above was wrote, I find that Professor Euler, in the Berlin Acts for the year 1748, in a memoire intituled, *Maxims pour aranger le plus avantageusement les machines destinées à elever de l'eau par le moyen de pompes*, page 192. § 9. has the following passage; which seems to be the more remarkable, as I don't find he has given any demonstration of the principle therein contained, either from theory or experiment; or has made any use thereof in his calculations on this subject.—“ *Cependant dans ce cas puisque l'eau est reflexie, & qu'elle decoule sur les aubes vers les cotés, elle y exerce encore une force particuliere, dont l'effet de l'impulsion sera augmenté; & experience jointe a la theorie a fait voir que dans ce cas, la force est presque double: de sorte qu'il faut prendre le double de le section du fil d'eau pour ce qui repond dans ce cas a le surface des aubes, pourvu qu'elles soient assez larges pour recevoir ce supplement de force. Car si les aubes nétoient plus larges que le fil, on trait d'eau on ne devroit prendre que ne simple section, tout comme dans le premier cas, on l'aube toute entiere est pappee par l'eau.*”

T A B L E I.

N ^o	Height of the water in the cistern.		Virtual head deduced therefrom.	Turns at the maxim ^m .	Load at the equilibrium.		Water expended in a minute.	Power.	Effect.	Ratio of the power and effect.	Ratio of the velocity of the water and wheel.	Ratio of the load at the equilibrium, to the load at the maximum.	Experiments.
	In.	Turns of the wheel unloaded.			lb. oz.	lb. oz.							
1	33	88	15,85	30,	13 10	10 9	275,	4358	1411	10:3,24	10:3,4	10:7,75	
2	30	86	15,0	30,	12 10	9 6	264,7	3970	1266	10:3,2	10:3,5	10:7,4	
3	27	82	13,7	28,	11 2	8 6	243,	3329	1044	10:3,15	10:3,4	10:7,5	
4	24	78	12,3	27,7	9 10	7 5	235,	2890	901,4	10:3,12	10:3,55	10:7,53	
5	21	75	11,4	25,9	8 10	6 5	214,	2439	735,7	10:3,02	10:3,45	10:7,32	
6	18	70	9,95	23,5	6 10	5 5	199,	1970	561,8	10:2,85	10:3,36	10:8,02	
7	15	65	8,54	23,4	5 2	4 4	178,5	1524	442,5	10:2,9	10:3,6	10:8,3	
8	12	60	7,29	22,	3 10	3 5	161,	1173	328	10:2,8	10:3,77	10:9,1	
9	9	52	5,47	19,	2 12	2 8	134,	733	213,7	10:2,9	10:3,65	10:9,1	
10	6	42	3,55	16,	1 12	1 10	114,	404,7	117	10:2,82	10:3,8	10:9,3	At the 1st hole.
11	24	84	14,2	30,75	13 10	10 14	342,	4890	1505	10:3,075	10:3,66	10:7,9	
12	21	81	13,5	29,	11 10	9 6	297,	4009	1223	10:3,01	10:3,62	10:8,05	
13	18	72	10,5	26,	9 10	8 7	285,	2993	975	10:3,25	10:3,6	10:8,75	
14	15	69	9,6	25,	7 10	6 14	277,	2659	774	10:2,92	10:3,62	10:9,	At the 2d.
15	12	63	8,0	25,	5 10	4 14	234,	1872	549	10:2,94	10:3,97	10:8,7	
16	9	56	6,37	23,	4 0	3 13	201,	1280	390	10:3,05	10:4,1	10:9,5	
17	6	46	4,25	21,	2 8	2 4	167,5	712	212	10:2,98	10:4,55	10:9,	
18	15	72	10,5	29,	11 10	9 6	357,	3748	1210	10:3,23	10:4,02	10:8,05	
19	12	66	8,75	26,75	8 10	7 6	330,	2887	878	10:3,05	10:4,05	10:8,1	The 3d.
20	9	58	6,8	24,5	5 8	5 0	255,	1734	541	10:3,01	10:4,22	10:9,1	
21	6	48	4,7	23,5	3 2	3 0	228,	1064	317	10:2,99	10:4,9	10:9,6	
22	12	68	9,3	27,	9 2	8 6	359,	3338	1006	10:3,02	10:3,97	10:9,17	
23	9	58	6,8	26,25	6 2	5 13	332,	2257	686	10:3,04	10:4,52	10:9,5	4th.
24	6	48	4,7	24,5	3 12	3 8	262,	1231	385	10:3,13	10:5,1	10:9,35	
25	9	60	7,29	27,3	6 12	6 6	355,	2588	783	10:3,03	10:4,55	10:9,45	
26	6	50	5,03	24,6	4 6	4 1	307,	1544	450	10:2,92	10:4,9	10:9,3	5th.
27	6	50	5,03	26,	4 15	4 9	360,	1811	534	10:2,95	10:5,2	10:9,25	6th.
1.	2.	3.	4.	5.	6.	7.	8.	9.	10.	11,	12.	13.	

Maxims and Observations deduced from the foregoing Table of Experiments.

Maxim I. *That the virtual or effective head being the same, the effect will be nearly as the quantity of water expended.*

This will appear by comparing the contents of the columns 4, 8, and 10, in the foregoing sets of experiments; as for

Example 1st, taken from N^o. 8. and 25, viz.

N ^o .	Virtual Head.	Water expended.	Effect.
8	7,29	161	328
25	7,29	355	785

Now the heads being equal, if the effects are proportioned to the water expended, we shall have by maxim 1st, 161 : 355 :: 328 : 723; but 723 falls short of 785, as it turns out in experiment according to N^o. 25, by 62; the effect therefore of N^o. 25, compared with N^o. 8, is greater than according to the present maxim in the ratio of 14 to 13.

The foregoing example, with four similar ones, are seen at one view in the following Table.

Examples	N ^o Tab. I.	Virtual Head.	Expende of Water.	Effect.	Comparison.	Variation	Proportional Variation.
1st	8	<i>Inch.</i> 7,29	<i>lb.</i> 161	328	161 : 355 :: 328 : 723	62+	14 : 13
	25	7,29	355	785			
2d	13	10,5	285	975	285 : 357 :: 975 : 1221	11—	121 : 122
	18	10,5	357	1210			
3d	22	6,8	255	541	255 : 332 :: 541 : 704	18—	38 : 39
	23	6,8	332	686			
4th	21	4,7	228	317	228 : 262 :: 317 : 364	21+	18 : 17
	24	4,7	262	385			
5th	26	5,03	307	450	307 : 360 :: 450 : 531	3+	178 : 177
	27	5,03	360	534			

Hence

Hence therefore, in comparing different experiments, as some fall short, and others exceed the maximum, and all agree therewith, as near as can be expected, in an affair where so many different circumstances are concerned; we may, according to the laws of reasoning by induction, conclude the maxim true; *viz.* that the effects are nearly as the quantity of water expended.

Maxim II. *That the expence of water being the same, the effect will be nearly as the height of the virtual or effective head.*

This also will appear by comparing the contents of columns 4, 8, and 10, in any of the sets of experiments.

Example 1st, of N^o. 2. and N^o. 24. viz.

No.	Virt. Head.	Expence.	Effect.
2	15	264,7	1266
24	4,7	262	385

Now as the expences are not quite equal, we must proportion one of the effects accordingly: thus

by maxim 1st, 262 : 264,7 :: 385 : 389
and by max. 2d, 15 : 4,7 :: 1266 : 397

Difference ——— 8

The effect therefore of N^o. 24. compared with N^o. 2. is less than according to the present maxim in the ratio of 49 : 50.

The foregoing, and two other similar examples, are comprised in the following Table.

Examples.	N ^o . Tab. I.	Virtual Head.	Expence of Water.	Effect.	Comparison.	Variation.	Proportional Variation.
1ft	2	15	264,7	1266	} Max. 1ft, 262 : 264,7 :: 385 : 319 } Max. 2d, 15 : 4,7 :: 1266 : 397	8	49 : 50
	24	4,7	262	385			
2d	1	15,85	275	1411	} Max. 1ft, 114 : 275 :: 117 : 282 } Max. 2d, 15,85 : 3,55 :: 1411 : 316	34	8 : 9
	10	3,55	114	117			
3d	11	14,2	342	1505	} Max. 1ft, 167,5 : 342 :: 212 : 433 } Max. 2d, 14,2 : 4,25 :: 1505 : 450	17	25 : 26
	17	4,25	1675	212			

Maxim III. *That the quantity of water expended being the same, the effect is nearly as the square of its velocity.*

This will appear by comparing the contents of columns 3, 8, and 10, in any of the sets of experiments ; as for

Example 1st of N^o. 2. with N^o. 24. viz.

N ^o .	Turns in a min.	Expence.	Effect.
2	86	264,7	1266
24	48	262	385

The velocity being as the number of turns, we shall have,

$$\begin{aligned} &\text{by max. 1ft, } 262 : 264,7 :: 385 : 389 \\ &\text{and by max. 3d, } \left\{ \begin{array}{l} 86^2 : 48^2 \\ 7396 : 2304 \end{array} \right\} :: 1266 : 394 \\ &\text{Difference} \quad \text{---} \quad 5 \end{aligned}$$

The effect therefore of N^o. 24. compared with N^o. 2. is less than by the present maxim in the ratio of 78 : 79.

The foregoing, and three other similar examples, are comprised in the following Table.

Examples.

Examples.	No. Tab. I.	Turns in a minute.	Expenditure of Water.	Effect.	Comparison.	Variation.	Proportional Variation.
1st	2	86	264.7	1266	{ Max. 1st, 262 : 264.7 :: 385 : 389 } { Max. 3d, { 86 ² : 48 ² } :: 1266 : 394 }	} 5 —	78 : 79
	24	48	262	385			
2d	1	88	275	1411	{ Max. 1st, 114 : 275 :: 117 : 282 } { Max. 3d, { 88 ² : 42 ² } :: 1411 : 321 }	} 39 —	7 : 8
	10	42	114	117			
3d	11	84	342	1505	{ Max. 1st, 167.5 : 342 :: 212 : 433 } { Max. 3d, { 84 ² : 46 ² } :: 1505 : 451 }	} 18 —	24 : 25
	17	46	167.5	212			
4 th	18	72	357	1210	{ Max. 1st, 228 : 357 :: 317 : 496 } { Max. 3d, { 72 ² : 48 ² } :: 1210 : 538 }	} 42 —	12 : 13
	21	48	228	317			

Maxim

Maxim 4th. *The aperture being the same, the effect will be nearly as the cube of the velocity of the water.*

This also will appear by comparing the contents of columns 3, 8, and 10; as for

Example 1st, of N^o. 1. and N^o. 10, viz.

N ^o .	Turns.	Expence.	Effect.
1	88	275	1411
10	42	114	117

Lemma. It must here be observed, that if water passes out of an aperture, in the same section, but with different velocities; the expence will be proportional to the velocity; and therefore conversely, if the expence is not proportional to the velocity, the section of the water is not the same.

Now comparing the water discharged with the turns of N^o. 1. and 10, we shall have 88 : 42 :: 275 : 131,2; but the water discharged by N^o. 10. is only 114 lb. therefore, tho' the sluice was drawn to the same height in N^o. 10. as in N^o. 1. yet the section of the water passing out, was less in N^o. 10. than N^o. 1. in the proportion of 114 to 131,2; consequently had the effective aperture or section of the water been the same in N^o. 10. as in N^o. 1. so that 131,2 lb. of water had been discharged instead of 114, the effect would have been increased in the same proportion; that is,

by the *Lemma*, 88 : 42 :: 275 : 131,2

by maxim 1st, 114 : 131,2 :: 117 : 134,5

and by max. 4th, $\left\{ \begin{array}{l} 83^3 : 42^3 \\ 681472 : 74088 \end{array} \right\} :: 1411 : 153,5$

Difference — 19

The

The effect therefore of N^o. 10. compared with N^o. 1. is less than it ought to be by the present maxim in the ratio of 7 : 8.

The foregoing, and three other similar examples, are contained in the following Table.

Examples.	N ^o . Tab. I.	Turns in a minute.	Expense of water.	Effect.	Comparison.	Variation.	Proportional Variation.
1 st	{ 1 10 }	{ 88 42 }	{ 275 114 }	{ 1411 117 }	{ Lemma. 88 : 42 :: 275 : 131,2 Max. 1. 114 : 131,2 :: 117 : 134,5 Max. 4. 88 ³ : 42 ³ :: 1411 : 153,5 }	19	7 : 8
2 ^d	{ 11 17 }	{ 84 46 }	{ 342 167,5 }	{ 1505 212 }	{ Lemma. 84 : 46 :: 342 : 187,3 Max. 1. 167,5 : 187,3 :: 212 : 237 Max. 4. 84 ³ : 46 ³ :: 1505 : 247 }	10	23 : 24
3 ^d	{ 18 21 }	{ 72 48 }	{ 357 228 }	{ 1210 317 }	{ Lemma. 72 : 48 :: 357 : 238 Max. 1. 228 : 238 :: 317 : 331 Max. 4. 72 ³ : 48 ³ :: 1210 : 355 }	24	14 : 15
4 th	{ 22 24 }	{ 68 48 }	{ 359 262 }	{ 1006 385 }	{ Lemma. 68 : 48 :: 359 : 253,4 Max. 1. 262 : 253,4 :: 385 : 372 Max. 4. 68 ³ : 48 ³ :: 1006 : 354 }	18	20 : 19

OBSERVATIONS.

Observ. 1st. On comparing column 2d and 4th, Tab. I. it is evident, that the *virtual head* bears no certain proportion to the *head of water*; but that when the aperture is greater, or the velocity of the water issuing therefrom less, they approach nearer to a coincidence: and consequently in the large openings of mills and sluices, where great quantities of water are discharged from moderate heads, the head of water, and virtual head determined from the velocity, will nearly agree, as experience confirms.

Observ. 2d. Upon comparing the several proportions between the *power* and *effect* in column 11th, the most general is that of 10 to 3; the extremes 10 to 3,2 and 10 to 2,8; but as it is observable, that where the quantity of water, or the velocity thereof; that is, where the power is greatest, the 2d term of the ratio is greatest also: we may therefore well allow the proportion subsisting in large works, as 3 to 1.

Observ. 3d. The proportions of *velocities* between the *water* and *wheel* in column 12, are contained in the limits of 3 to 1 and 2 to 1; but as the greater velocities approach the limit of 3 to 1, and the greater quantity of water approach to that of 2 to 1, the best general proportion will be that of 5 to 2.

Observ. 4th. On comparing the numbers in column 13, it appears, that there is no certain ratio between the *load* that the wheel will carry at its *maximum*, and what will totally stop it; but that they are contained within the limits of 20 to 19, and

of 20 to 15; but as the effect approaches nearest to the ratio of 20 to 15, or of 4 to 3, when the power is greatest, whether by increase of velocity, or quantity of water, this seems to be the most applicable to large works: but as the load that a wheel ought to have, in order to work to the best advantage, can be assigned, by knowing the effect it ought to produce, and the velocity it ought to have in producing it; the exact knowledge of the greatest load it will bear, is of the less consequence in practice.

It is to be noted, that in all the examples under the three last of the four preceding maxims, the effect of the lesser power falls short of its due proportion to the greater, when compared by its maxim; except the last example of maxim 4th: and hence, if the experiments are taken strictly, we must infer, that the effects increase and diminish in an higher ratio than those maxims suppose: but as the deviation is not very considerable, the greatest being about 1-8th of the quantity in question; and as it is not easy to make experiments of so compounded a nature with absolute precision; we may rather suppose, that the lesser power is attended with some friction, or works under some disadvantage, which has not been duly accounted for, and therefore we may conclude, that these maxims will hold very nearly, when applied to works in large.

After the experiments above mentioned were tried, the wheel, which had originally 24 floats, was reduced to twelve; which caused a diminution in the effect, on account of a greater quantity of water escaping between the floats and the floor; but a cir-

cular sweep being adapted thereto, of such a length, that one float entered the curve before the preceding one quitted it, the effect came so near to the former, as not to give hopes of advancing it by increasing the number of floats beyond 24 in this particular wheel.

P A R T II.

Concerning O V E R S H O T W H E E L S.

Read May 24, 1759. **I**N the former part of this essay, we have considered the impulse of a confined stream, acting on *Undershot Wheels*. We now proceed to examine the power and application of water, when acting by its *gravity* on *Overshot Wheels*.

In reasoning without experiment, one might be led to imagine, that however different the mode of application is; yet that whenever the same quantity of water descends thro' the same perpendicular space, that the natural effective power would be equal; supposing the machinery free from friction, equally calculated to receive the full effect of the power, and to make the most of it: for if we suppose the height of a column of water to be 30 inches, and resting upon a base or aperture of one inch square; every cubic inch of water that departs therefrom will acquire the same velocity or *momentum*, from the uniform pressure of 30 cubic inches above it, that one cubic inch let fall from the top will acquire in falling down to the level of the aperture; *viz.* such a velocity as in a contrary direction would carry it to
the

the level from whence it fell; * one would therefore suppose, that a cubic inch of water, let fall thro' a space of 30 inches, and there impinging upon another body, would be capable of producing an equal effect by collision, as if the same cubic inch had descended thro' the same space with a slower motion, and produced its effects gradually: for in both cases gravity acts upon an equal quantity of matter, thro' an equal space †; and consequently, that whatever was the ratio between the power and effect in undershot wheels, the same would obtain in overshot, and indeed in all others: yet, however conclusive this reasoning may seem, it will appear, in the course of the following deductions, that the effect of the gravity of descending bodies is very different from the effect of the stroke of such as are *non-elastic*, tho' generated by an equal mechanical power.

The alterations in the machinery already described, to accommodate the same for experiments on overshot wheels, were principally as follows.

PLATE V. *Fig. 2.* The sluice *Ib* being shut down, the rod *HI* was unscrewed and taken off.

The undershot water-wheel was taken off the axis, and instead thereof an overshot wheel of the same

* This is a consequence of the rising of jets to the height of their reservoirs nearly.

† Gravity, it is true, acts a longer space of time upon the body that descends slow than upon that which falls quick; but this cannot occasion the difference in the effect: for an elastic body falling thro' the same space in the same time, will, by collision upon another elastic body, rebound nearly to the height from which it fell; or, by communicating its motion, cause an equal one to ascend to the same height.

diameter was put into its place. *Note*, This wheel was two inches in the shroud or depth of the bucket ; the number of the buckets was 36.

The standards S and T, *Fig. 1.* were raised half an inch, so that the bottom of the wheel might be clear of stagnant water.

A trunk, for bringing the water upon the wheel, was fixed according to the dotted lines *f g*, *Fig. 2.* The aperture was adjusted by a shuttle *b i*, which also closed up the outer end of the trunk, when the water was to be stopped.

Fig. 3. The ratchet *o o*, not being of one piece of metal with the ferrule *e e*, *i i* (tho' so described before, to prevent unnecessary distinctions), was with its catch turned the contrary side ; consequently the moveable barrel would do its office equally, notwithstanding the water-wheel, when at work, moved the contrary way.

Specimen of a Sett of Experiments.

Head 6 inches.

14 $\frac{1}{2}$ strokes of the pump in a minute, 12 ditto =
80 lb. *

Weight of the scale (being wet) 10 $\frac{1}{2}$ oz.

Counterweight for 20 turns, besides the scale, 3 oz.

No.	Weight in the Scale.	Turns.	Product.	Observations.
1	0 lb.	60	—	Threw most part of the water out of the wheel.
2	1	56	—	
3	2	52	—	
4	3	49	147	Received the water more quietly.
5	4	47	188	
6	5	45	225	
7	6	42 $\frac{1}{2}$	255	
8	7	41	287	
9	8	38 $\frac{1}{2}$	308	
10	9	36 $\frac{1}{2}$	328 $\frac{1}{2}$	
11	10	35 $\frac{1}{2}$	355	
12	11	32 $\frac{3}{4}$	360 $\frac{1}{2}$	
13	12	31 $\frac{1}{4}$	375	
14	13	28 $\frac{1}{2}$	370 $\frac{1}{2}$	
15	14	27 $\frac{1}{2}$	385	
16	15	26	390	
17	16	24 $\frac{1}{2}$	392	
18	17	22 $\frac{3}{4}$	386 $\frac{3}{4}$	
19	18	21 $\frac{3}{4}$	391 $\frac{1}{2}$	
20	19	20 $\frac{3}{4}$	394 $\frac{1}{4}$	Maximum.
21	20	19 $\frac{3}{4}$	395	
22	21	18 $\frac{3}{4}$	388 $\frac{1}{4}$	
23	22	18	396	Work'd irregular.
24	23	Overfet by its load.		

* The small difference, in the value of 12 strokes of the pump, from the former experiments, was owing to a small difference in the length of the stroke, occasioned by the warping of the wood.

Reduction

Reduction of the preceding Specimen.

In these experiments the head being 6 inches, and the height of the wheel 24 inches, the whole descent will be 30 inches: the expence of water was $14\frac{1}{2}$ strokes of the pump in a minute, whereof 12 contained 80 lb.; therefore the water expended in a minute was $96\frac{2}{3}$ lb. which, multiplied by 30 inches, gives the *power* = 2900.

If we take the 20th experiment for the *maximum*, we shall have $20\frac{3}{4}$ turns in a minute, each of which raised the weight $4\frac{1}{2}$ inches, that is, 93,37 inches in a minute. The weight *in* the scale was 19 lb, the weight *of* the scale $10\frac{1}{2}$ oz.; the counter-weight 3 oz. in the scale, which, with the weight of the scale $10\frac{1}{2}$ oz. makes in the whole $20\frac{1}{2}$ lb. which is the whole resistance or load: this, multiplied by 93,37 inches, makes 1914 for the effect.

The *ratio* therefore of the *power* and *effect* will be as 2900 : 1914, or as 10 : 6,6, or as 3 : 2 nearly.

But if we compute the power from the height of the wheel only, we shall have $96\frac{2}{3}$ lb. multiplied by 24 inches = 2320 for the *power*, and this will be to the *effect* as 2320 : 1914, or as 10 : 82, or as 5 : 4 nearly.

The reduction of this specimen is set down in N^o. 9. of the following Table; and the rest were deducted from a similar set of experiments, reduced in the same manner.

TABLE II. containing the Result of Sixteen Sets of Experiments on Overshot Wheels.

N ^o .	Whole descent.	Water expended in a minute.	Turns at the maximum in a minute.	Weight raised at the maximum.	Power of the whole descent.	Power of the wheel.	Effect.	Ratio of the whole power and effect.	Ratio of power of the wheel and effect.	Mean ratio.
	Inch.	lb.		lb.						
1	27	30	19	6 $\frac{1}{2}$	810	720	556	10 : 6,9	10 : 7,7	
2	27	56 $\frac{1}{2}$	16 $\frac{1}{4}$	14 $\frac{1}{2}$	1530	1360	1060	10 : 6,9	10 : 7,8	
3	27	56	20	12 $\frac{1}{2}$	1530	1360	1167	10 : 7,6	10 : 8,4	
4	27	63	20	13	1710	1524	1245	10 : 7,3	10 : 8,2	
5	27	76	21	15 $\frac{1}{2}$	2070	1840	1500	10 : 7,3	10 : 8,2	
6	28 $\frac{1}{2}$	73 $\frac{1}{2}$	18 $\frac{3}{4}$	17 $\frac{1}{2}$	2090	1764	1476	10 : 7,	10 : 8,4	
7	28 $\frac{1}{2}$	96 $\frac{1}{2}$	20 $\frac{1}{4}$	20 $\frac{1}{2}$	2755	2320	1868	10 : 6,8	10 : 8,	
8	30	90	20	19 $\frac{1}{2}$	2700	2160	1755	10 : 6,5	10 : 8,1	
9	30	96 $\frac{1}{2}$	20 $\frac{3}{4}$	20 $\frac{1}{2}$	2900	2320	1914	10 : 6,6	10 : 8,2	
10	30	113 $\frac{1}{3}$	21	23 $\frac{1}{2}$	3400	2720	2221	10 : 6,5	10 : 8,2	10 : 8,2
11	33	56 $\frac{2}{3}$	20 $\frac{1}{4}$	13 $\frac{1}{2}$	1870	1360	1230	10 : 6,6	10 : 9,	
12	33	106 $\frac{1}{3}$	22 $\frac{1}{4}$	21 $\frac{1}{2}$	3520	2560	2153	10 : 6,1	10 : 8,4	
13	33	146 $\frac{1}{3}$	23	27 $\frac{1}{2}$	4840	3520	2846	10 : 5,9	10 : 8,1	10 : 8,5
14	35	65	19 $\frac{3}{4}$	16 $\frac{1}{2}$	2275	1560	1466	10 : 6,5	10 : 9,4	
15	35	120	21 $\frac{1}{2}$	25 $\frac{1}{2}$	4200	2880	2467	10 : 5,9	10 : 8,6	
16	35	163 $\frac{1}{2}$	25	26 $\frac{1}{2}$	5728	3924	2981	10 : 5,2	10 : 7,6	10 : 8,5
1.	2.	3.	4.	5.	6.	7.	8.	9.	10.	11

Observations and Deductions from the foregoing Experiments.

I. Concerning the Ratio between the Power and Effect of Overshot Wheels.

The effective power of the water must be reckoned upon the whole descent ; because it must be raised

raised that height, in order to be in a condition of producing the same effect a second time.

The ratio's between the *powers* so estimated, and the *effects* at the *maximum* deduced from the several sets of experiments, are exhibited at one view in column 9. of Table II.; and from hence it appears, that those ratio's differ from that of 10 to 7,6 to that of 10 : 5,2, that is, nearly from 4 : 3 to 4 : 2. In those experiments where the heads of water and quantities expended are least, the proportion is nearly as 4 : 3 ; but where the heads and quantities are greatest, it approaches nearer to that of 4 : 2 ; and by a medium of the whole, the ratio is that of 3 : 2 nearly. We have seen before, in our observations upon the effects of undershot wheels, that the general ratio of the power to the effect, when greatest, was 3 : 1 ; *the effect therefore of overshot wheels, under the same circumstances of quantity and fall, is at a medium double to that of the undershot* : and, as a consequence thereof, *that nonelastic bodies, when acting by their impulse or collision, communicate only a part of their original power* ; the other part being spent in changing their figure in consequence of the stroke.

The powers of water computed from the height of the wheel only, compared with the effects, as in column 10. appear to observe a more constant ratio : for if we take the medium of each class, which is set down in column 11, we shall find the extremes to differ no more than from the ratio of 10 : 8,1 to that of 10 : 8,5 ; and as the second term of the ratio gradually increases from 8,1 to 8,5, by an increase of head from 3 inches to 11, the excess of 8,5 above

8,1 is to be imputed to the superior impulse of the water at the head of 11 inches above that of 3 inches: so that if we reduce 8,1 to 8, on account of the impulse of the 3 inch head, *we shall have the ratio of the power, computed upon the height of the wheel only, to the effect at a maximum as 10 : 8, or as 5 : 4 nearly*: and from the equality of the ratio between power and effect, subsisting where the constructions are similar, we must infer, *that the effects, as well as the powers, are as the quantities of water and perpendicular heights multiplied together respectively.*

II. Concerning the most proper Height of the Wheel in proportion to the whole Descent.

We have already seen, from the preceding observation, that the effect of the same quantity of water, descending thro' the same perpendicular space, is double, when acting by its gravity upon an overshot wheel, to what the same produces when acting by its impulse upon an undershot. It also appears, that by increasing the head from 3 inches to 11, that is, the whole descent, from 27 inches to 35, or in the ratio of 7 to 9 nearly, the effect is advanced no more than in the ratio of 8,1 to 8,4, that is, as 7 : 7,26; and consequently the increase of effect as not 1-7th of the increase of perpendicular height. Hence it follows, *that the higher the wheel is in proportion to the whole descent, the greater will be the effect*; because it depends less upon the impulse of the head, and more upon the gravity of the water in the buckets: and if we consider how obliquely the water issuing from the head must strike the buckets, we shall not be at a loss to account for the little ad-

vantage that arises from the impulse thereof; and shall immediately see of how little consequence this impulse is to the effect of an overshot wheel. However, as every thing has its limits, so has this: for thus much is desirable, *that the water should have somewhat greater velocity, than the circumference of the wheel, in coming thereon*; otherwise the wheel will not only be retarded, by the buckets striking the water, but thereby dashing a part of it over, so much of the power is lost.

The velocity that the circumference of the wheel ought to have, being known by the following deductions, the head requisite to give the water its proper velocity is easily computed from the common rules of hydrostatics; and will be found much less than what is generally practised.

III. *Concerning the Velocity of the Circumference of the Wheel, in order to produce the greatest Effect.*

If a body is let fall freely from the surface of the head to the bottom of the descent, it will take a certain time in falling; and in this case the whole action of gravity is spent in giving the body a certain velocity: but if this body in falling is made to act upon some other body, so as to produce a mechanical effect, the falling body will be retarded; because a part of the action of gravity is then spent in producing the effect, and the remainder only giving motion to the falling body: and therefore *the slower a body descends, the greater will be the portion of the action of gravity applicable to the producing a mechanical effect*; and in consequence the greater that effect may be.

If a stream of water falls into the bucket of an overshot wheel, it is there retained till the wheel by moving round discharges it: of consequence the slower the wheel moves, the more water each bucket will receive: so that what is lost in speed, is gained by the pressure of a greater quantity of water acting in the buckets at once: and, if considered only in this light, the mechanical power of an overshot wheel to produce effects will be equal, whether it moves quick or slow: but if we attend to what has been just now observed of the falling body, it will appear that so much of the action of gravity, as is employed in giving the wheel and water therein a greater velocity, must be subtracted from its pressure upon the buckets; so that, tho' the product made by multiplying the number of cubic inches of water acting in the wheel at once by its velocity will be the same in all cases; yet, as each cubic inch, when the velocity is *greater* does not press so much upon the bucket as when it is *less*, the power of the water to produce effects will be greater in the less velocity than in the greater: and hence we are led to this general rule, *that, cæteris paribus, the less the velocity of the wheel, the greater will be the effect thereof.* A confirmation of this doctrine, together with the limits it is subject to in practice, may be deduced from the foregoing specimen of a sett of experiments.

From these experiments it appears, that when the wheel made about 20 turns in a minute, the effect was, near upon, the greatest. When it made 30 turns, the effect was diminished about $\frac{1}{20}$ part; but that when it made 40, it was diminished about $\frac{1}{4}$; when it made less than 18 $\frac{1}{4}$, its motion was irregular; and
when

when it was loaded so as not to admit its making 18 turns, the wheel was overpowered by its load.

It is an advantage in practice, that the velocity of the wheel should not be diminished further than what will procure some solid advantage in point of power; because, *cæteris paribus*, as the motion is slower, the buckets must be made larger; and the wheel being more loaded with water, the stress upon every part of the work will be increased in proportion: *The best velocity for practice therefore will be such, as when the wheel here used made about 30 turns in a minute; that is, when the velocity of the circumference is a little more than 3 feet in a second.*

Experience confirms, that this velocity of 3 feet in a second is applicable to the highest overshot wheels, as well as the lowest; and all other parts of the work being properly adapted thereto, will produce very nearly the greatest effect possible: however this also is certain from experience, that *high wheels may deviate further from this rule, before they will lose their power, by a given aliquot part of the whole, than low ones can be admitted to do*; for a wheel of 24 feet high may move at the rate of six feet per second without losing any considerable part of its power*; and, on the other hand, I have seen a wheel of 33 feet high, that has moved very steadily and well with a velocity but little exceeding 2 feet.

* The 24 feet wheel going at 6 feet in a second seems owing to the small proportion that the head (requisite to give the water the proper velocity of the wheel) bears to the whole height.

IV. *Concerning the Load for an Overshot Wheel, in order that it may produce a Maximum.*

The maximum load for an overshot wheel, is that which reduces the circumferences of the wheel to its proper velocity; and this will be known, by dividing the effect it ought to produce in a given time by the space intended to be described by the circumference of the wheel in the same time: the quotient will be the resistance overcome at the circumference of the wheel; and is equal to the load required, the friction and resistance of the machinery included.

V. *Concerning the greatest possible Velocity of an Overshot Wheel.*

The greatest velocity that the circumference of an overshot wheel is capable of, depends jointly upon the diameter or *height* of the wheel, and the velocity of falling bodies; for it is plain that the velocity of the circumference can never be greater, than to describe a semi-circumference, while a body let fall from the top of the wheel will descend thro' its diameter; nor indeed quite so great, as a body descending thro' the same perpendicular space cannot perform the same in so small a time when passing thro' a semi-circle, as would be done in a perpendicular line. Thus, if a wheel is 16 feet 1 inch high, a body will fall thro' the diameter in one second: this wheel therefore can never arrive at a velocity equal to the making one turn in two seconds; but, in reality, an overshot wheel can never come near this velocity; for when it acquires a certain speed,
the

the greatest part of the water is prevented from entering the buckets; and the rest, at a certain point of its descent, is thrown out again by the centrifugal force. This appears to have been the case in the three first experiments of the foregoing specimen; but as the velocity, when this begins to happen, depends upon the form of the buckets, as well as other circumstances, *the utmost velocity of overshot wheels is not to be determined generally*: and, indeed, it is the less necessary in practice, as it is in this circumstance incapable of producing any *mechanical effect*, for reasons already given.

VI. *Concerning the greatest Load that an Overshot Wheel can overcome.*

The greatest load an overshot wheel will overcome, considered abstractedly, is unlimited or infinite: for as the buckets may be of any given capacity, the more the wheel is loaded, the slower it turns; but the slower it turns, the more will the buckets be filled with water; and consequently tho' the diameter of the wheel, and quantity of water expended, are both limited, yet no resistance can be assigned, which it is not able to overcome: but in practice we always meet with something that prevents our getting into infinitesimals; for when we really go to work to build a wheel, the buckets must necessarily be of some given capacity; and consequently *such a resistance will stop the wheel, as is equal to the effort of all the buckets in one semi-circumference filled with water.*

The structure of the buckets being given, the quantity of this effort may be assigned; but is not of much consequence to the practice, as in this case
also

also the wheel loses its power; for tho' here is the exertion of gravity upon a given quantity of water, yet being prevented by a counterbalance from moving, is capable of producing no *mechanical effect*, according to our definition. But, in reality, an overshot wheel generally ceases to be useful before it is loaded to that pitch; for *when it meets with such a resistance as to diminish its velocity to a certain degree, its motion becomes irregular; yet this never happens till the velocity of the circumference is less than 2 feet per second, where the resistance is equable*, as appears not only from the preceding specimen, but from experiments on larger wheels.

SCHOLIUM.

Having now examined the different effects of the power of water, when acting by its *impulse*, and by its *weight*, under the titles of *undershot* and *overshot* wheels; we might naturally proceed to examine the effects when the impulse and weight are combined, as in the several kinds of *breast-wheels*, &c. but, what has been already delivered being carefully attended to, the application of the same principles in these mixt cases will be easy, and reduce what I have to say on this head into a narrow compass: for all kinds of wheels where the water cannot descend thro' a given space, unless the wheel moves therewith, are to be considered of the nature of an overshot wheel, according to the perpendicular height that the water descends from; and all those that receive the impulse or shock of the water, whether in an horizontal, perpendicular, or oblique direction, are to be considered as undershots. And therefore a wheel, which the

water strikes at a certain point below the surface of the head, and after that descends in the arch of a circle, pressing by its gravity upon the wheel; *the effect of such a wheel will be equal to the effect of an undershot, whose head is equal to the difference of level between the surface of the water in the reservoir and the point where it strikes the wheel, added to that of an overshot, whose height is equal to the difference of level, between the point where it strikes the wheel and the level of the tail-water.* It is here supposed, that the wheel receives the shock of the water at right angles to its radii; and that the velocity of its circumference is properly adapted to receive the utmost advantage of both these powers; otherwise a reduction must be made on that account.

Many obvious and considerable improvements upon the common practice naturally offer themselves, from a due consideration of the principles here established, as well as many popular errors show themselves in view: but as my present purpose extends no farther than the laying down such general rules as will be found to answer in practice, I leave the particular application to the intelligent artist, and to the curious in these matters.

P A R T III.

On the Construction and Effects of WINDMILL-SAILS.

Read 31 May & 14 June, 1759. **I**N trying experiments on windmill-fails, the wind itself is too uncertain to answer the purpose: we must therefore have recourse to an artificial wind.

This

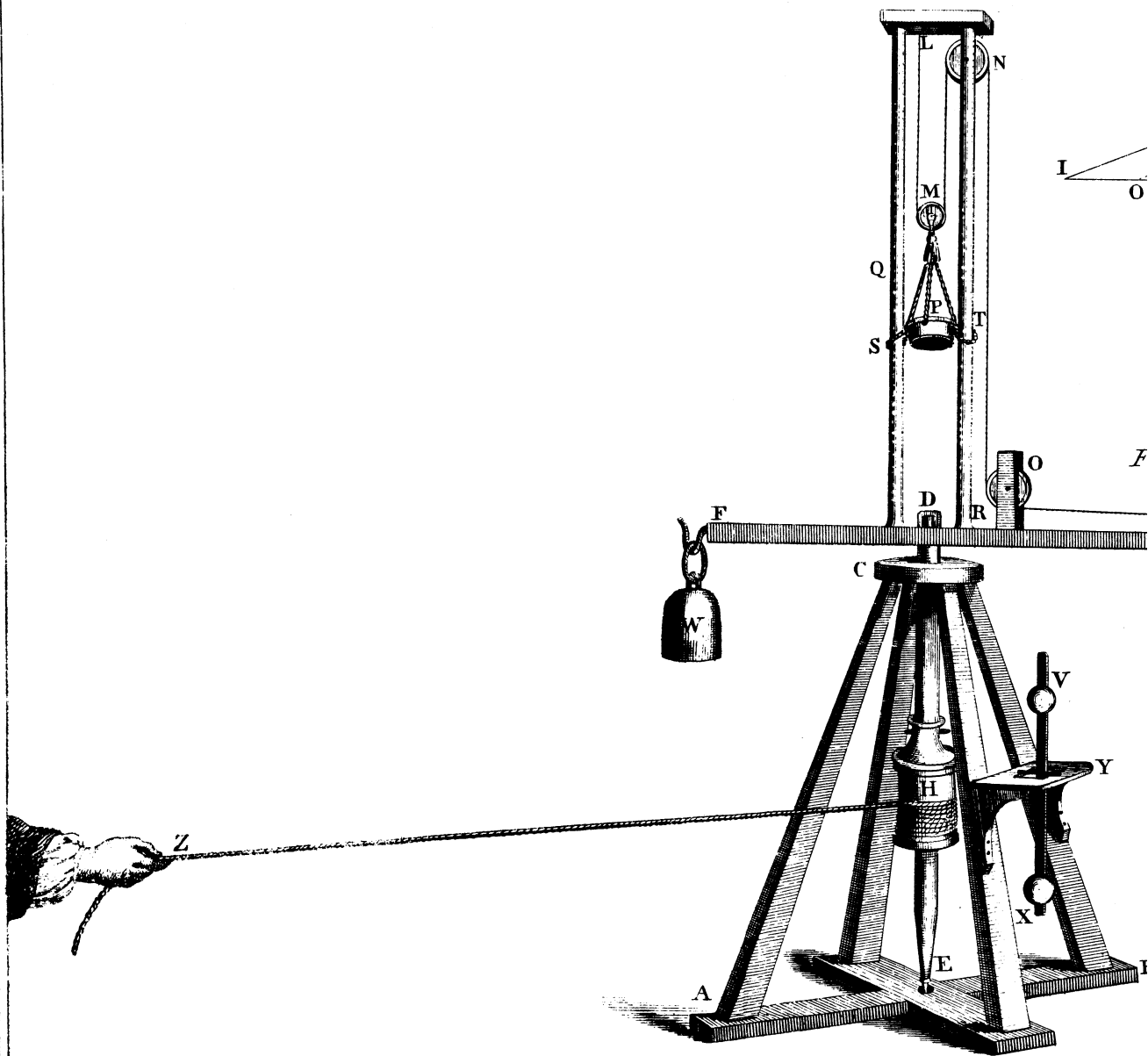

J. Smooton delin.

Inches
 12 6 0 1 2 3
 Scale of Feet

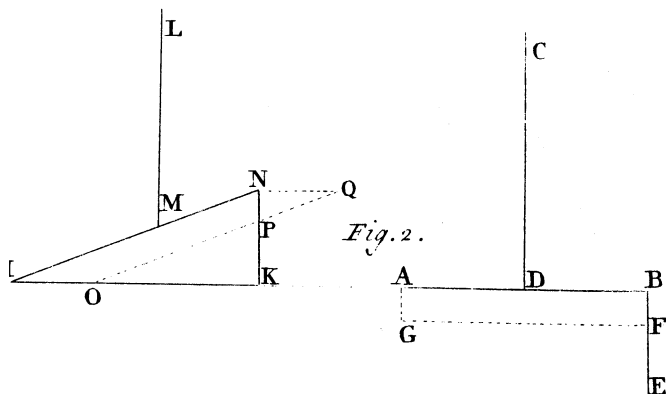
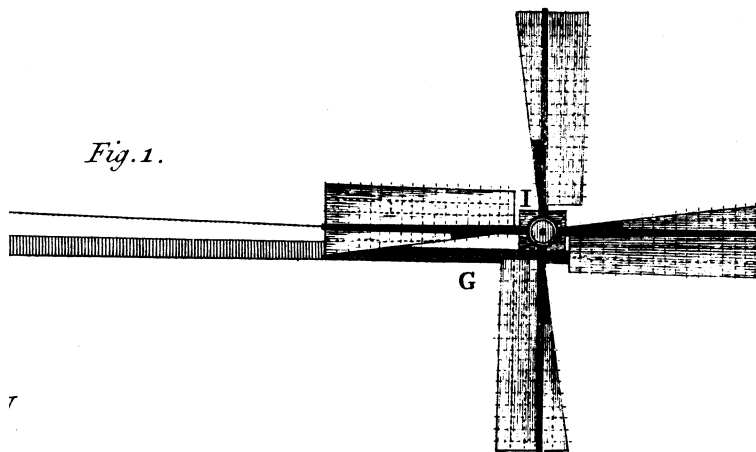

Fig. 1.



This may be done two ways; either by causing the air to move against the machine, or the machine to move against the air. To cause the air to move against the machine, in a sufficient column, with steadiness and the requisite velocity, is not easily put in practice: To carry the machine forward in a right line against the air, would require a larger room than I could conveniently meet with. What I found most practicable, therefore, was, to carry the axis, whereon the sails were to be fixed, progressively round in the circumference of a large circle. Upon this idea * a machine was constructed, as follows.

PLATE VI. *Fig. I.*

ABC is a pyramidal frame for supporting the moving parts.

DE is an upright axis, whereon is framed

FG, an arm for carrying the sails at a proper distance from the center of the upright axis.

* Some years ago Mr. Rouse, an ingenious gentleman of Harborough in Leicestershire, set about trying experiments on the velocity of the wind, and force thereof upon plain surfaces and windmill-sails: and much about the same time Mr. Ellicott contrived a machine for the use of the late celebrated Mr. B. Robins, for trying the resistance of plain surfaces moving thro' the air. The machines of both these gentlemen were much alike, tho' at that time totally unacquainted with each other's inquiries. But it often happens, that when two persons think justly upon the same subject, their experiments are alike. This machine was also built upon the same idea as the foregoing; but differed in having the hand for the first mover, with a pendulum for its regulator, instead of a weight, as in the former; which was certainly best for the purposes of measuring the impulse of the wind, or resistance of plains: but the latter is more applicable to experiments on windmill-sails; because every change of position of the same sails will occasion their meeting the air with a different velocity, tho' urged by the same weight.

H is a barrel upon the upright axis, whereon is wound a cord; which, being drawn by the hand, gives a circular motion to the axis, and to the arm *FG*; and thereby carries the axis of the sails in the circumference of a circle, whose radius is *DI*, causing thereby the sails to strike the air, and turn round upon their own axis.

At L is fixed the end of a small line, which passing through the pullies *MNO*, terminates upon a small cylinder or barrel upon the axis of the sails, and, by winding thereon, raises

P the scale, wherein the weights are placed for trying the power of the sails. This scale, moving up and down in the direction of the upright axis, receives no disturbance from the circular motion.

QR two parallel pillars standing upon the arm *FG*, for the purpose of supporting and keeping steady the scale *P*; which is kept from swinging by means of

ST two small chains, which hang loosely round the two pillars.

W is a weight, for bringing the center of gravity of the moveable part of the machine into the center of motion of the axis *DE*.

VX is a pendulum, composed of two balls of lead, which are moveable upon a wooden rod, and thereby can be so adjusted, as to vibrate in any time required. This pendulum hangs upon a cylindrical wire, whereon it vibrates, as on a rolling axis.

Y is a perforated table for supporting the axis of the pendulum.

Note,

Note, The pendulum being so adjusted, as to make two vibrations in the time that the arm FG is intended to make one turn; the pendulum being set a vibrating, the experimenter pulls by the cord Z, with sufficient force to make each half revolution of the arm to correspond with each vibration, as equal as possible, during the number of vibrations that the experiment is intended to be continued. A little practice renders it easy to give motion thereto with all the regularity that is necessary.

Specimen of a Sett of Experiments.

Radius of the sails	— — —	21 inches
Length of ditto in the cloth	— —	18
Breadth of ditto	— — —	5,6
* { Angle at the extremity	— —	10 degrees
{ Ditto at the greatest inclination	—	25
20 turns of the sails raised the weight		11, 3 inches
Velocity of the center of the sails, in the circumference of the great circle, in a second	— — — —	} 6 f. 0 in.
Continuance of the experiment	—	

N ^o .	Wt. in the scale.	Turns.	Product.
1	— 0 lb. —	108	— 0
2	— 6 —	85	— 510
3	— 6 $\frac{1}{2}$ —	81	— 526 $\frac{1}{2}$
4	— 7 —	78	— 546
5	— 7 $\frac{1}{2}$ —	73	— 547 $\frac{1}{2}$ maxim ^m
6	— 8 —	65	— 520
7	— 9 —	0	— 0

* In all the following experiments the angle of the sails is accounted from the plain of their motion; that is, when they stand at right angles to the axis, their angle is denoted 0°, this notation being agreeable to the language of practitioners, who call the angle so denoted, the weather of the sail; which they denominate greater or less, according to the quantity of this angle.

N. B. The weight of the scale and pulley was 3 oz.; and that 1 oz. suspended upon one of the radii, at $12\frac{1}{2}$ inches from the center of the axis, just overcame the friction scale and load of $7\frac{1}{2}$ lb.; and placed at $14\frac{1}{8}$ inches, overcame the same resistances with 9 lb. in the scale.

Reduction of the preceding Specimen.

N^o. 5. being taken for the maximum, the weight in the scale was 7 lb. 8 oz. which, with the weight of the scale and pulley 3 oz. makes 7 lb. 11 oz. equal to 123 oz.; this added to the friction of the machinery, the sum is the whole resistance *. The friction of the machinery is thus deduced: Since 20 turns of the fails raised the weight 11,3 inches, with a double line, the radius of the cylinder will be .18 of an inch; but had the weight been raised by a single line, the radius of the cylinder being half the former, viz. .09, the resistance would have been the same: we shall therefore have this analogy; as half the radius of the cylinder, is to the length of the arm where the small weight was applied; so is the weight applied to the arm, to a fourth weight, which is equivalent to the sum of the whole resistance together; that is, .09 : 12,5 :: 1 oz. : 139 oz.: this exceeds 123 oz. the weight in the scale, by 16 oz. or 1 lb. which is equivalent to the friction; and which, added to the above weight of 7 lb. 11 oz. makes 8 lb. 11 oz. = 8,69 lb. for the sum of the whole re-

* The resistance of the air is not taken into the account of resistance, because it is inseparable from the application of the power.

distance ; and this, multiplied by 73 turns, makes a product of 634, which may be called the representative of the *effect* produced.

In like manner, if the weight 9 lb. which caused the sails to rest after being in motion, be augmented by the weight of the scale and its relative friction, it will become 10,37 lb. The result of this specimen is set down in N^o. 12. of Table III. and the result of every other sett of experiments therein contained were made and reduced in the same manner.

TABLE III. Containing Nineteen Sets of Experiments on Windmill-Sails of various Structures, Positions, and Quantities of Surfaces.

The kind of sails made use of.	N ^o .	Angle at the extremities.	Greatest angle.	Turns of the sails unloaded.	Turns of ditto at the maximum.	Load at the maximum.	Greatest load.	Product.	Quantity of surface.	Ratio of greatest velocity to the velocity at a maximum.	Ratio of greatest load to the load at maximum.	Ratio of surface to the product.
						lb.	lb.		Sq. In			
Plain sails at an angle of 55°.	1	35	35	66	42	7,56	12,59	318	404	10:7	10:6	10:7,9
Plain sails weather'd according to the common practice.	2	12	12		70	6,3	7,56	441	404		10:8,3	10:10,1
	3	15	15	105	69	6,72	8,12	464	404	10:6,6	10:8,3	10:10,15
	4	18	18	96	66	7,0	9,81	462	404	10:7,	10:7,1	10:10,15
Weathered according to Maclaurin's theorem.	5	9	26½		66	7,0		462	404			10:11,4
	6	12	29½		70½	7,35		518	404			10:12,8
	7	15	32½		63½	8,3		527	404			10:13,
Sails weathered in the Dutch manner, tried in various positions.	8	0	15	120	93	4,75	5,31	442	404	10:7,7	10:8,9	10:11,
	9	3	18	120	79	7,0	8,12	553	404	10:6,6	10:8,6	10:13,7
	10	5	20		78	7,5	8,12	585	404		10:9,2	10:14,5
	11	7½	22½	113	77	8,3	9,81	639	404	10:6,8	10:8,5	10:15,8
	12	10	25	108	73	8,69	10,37	634	404	10:6,8	10:8,4	10:15,7
13	12	27	100	66	8,41	10,94		580	404	10:6,6	10:7,7	10:14,4
Sails weathered in the Dutch manner, but enlarged towards the extremities.	14	7½	22½	123	75	10,65	12,59	799	505	10:6,1	10:8,5	10:15,8
	15	10	25	117	74	11,08	13,69	820	505	10:6,3	10:8,1	10:16,2
	16	12	27	114	66	12,09	14,23	799	505	10:5,8	10:8,4	10:15,8
	17	15	30	96	63	12,09	14,78	762	505	10:6,6	10:8,2	10:15,1
8 sails being sectors of ellipses in their best positions.	18	12	22	105	64½	16,42	27,87	1059	854	10:6,1	10:5,9	10:12,4
	19	12	22	99	64½	18,06		1165	1146	10:5,9		10:10,1
	1.	2.	3.	4.	5.	6.	7.	8.	9.	10.	11.	12.

Observations

Observations and Deductions from the preceding Experiments.

I. Concerning the best Form and Position of Wind-mill-Sails.

In Table III. N^o. 1. is contained the result of a set of experiments upon sails set at the angle which the celebrated Monf. Parint, and succeeding geometers for many years, held to be the best; *viz.* those whose planes make an angle 55° nearly with the axis; the complement whereof, or angle that the plane of the sail makes with the plane of their motion, will therefore be 35° , as set down in col. 2. and 3. Now if we multiply their number of turns by the weight they lifted, when working to the greatest advantage, as set down in columns 5. and 6. and compare this product (col. 8.) with the other products contained in the same column, instead of being the greatest, it turns out the least of all the rest. But if we set the angle of the same planes at somewhat less than half the former, or at any angle from 15° to 18° , as in N^o. 3. and 4. that is, from 72° to 75° with the axis, the product will be increased in the ratio of 31 : 45; and this is the angle most commonly made use of by practitioners, when the surfaces of the sails are planes.

If nothing more was intended than to determine the most efficacious angle to make a mill acquire motion from a state of rest, or to prevent it from passing into rest from a state of motion, we shall find the position of N^o. 1. the best; for if we consult col. 7. which contains the least weights, that would make the sails pass from motion to rest, we shall find that of N^o. 1.

(relative to the quantity of cloth) the greatest of all. But if the sails are intended, with given dimensions, to produce the greatest effect possible in a given time, we must intirely reject those of N°. 1. and, *if we are confined to the use of planes, conform ourselves to some angle between N°. 3. and 4. that is, not less than 72°, or greater than 75°, with the axis.*

The late celebrated Mr. Maclaurin has judiciously distinguished between the action of the wind upon a sail at rest, and a sail in motion; and, in consequence, as the motion is more rapid near the extremities than towards the center, that the angle of the different parts of the sail, as they recede from the center, should be varied. For this purpose he has furnished us with the following theorem*. “Suppose the velocity of the wind to be represented by a , and the velocity of any given part of the sail to be denoted by c ; then the effort of the wind upon that part of the sail will be greatest when the tangent of the angle, in which the wind strikes it, is to radius as

“ $\sqrt{2 + \frac{9cc}{4aa} + \frac{3c}{2a}}$ to 1.” This theorem then assigns the law, by which the angle is to be varied according to the velocity of each part of the sail to the wind: but as it is left undetermined what velocity any one given part of the sail ought to have in respect to the wind, the angle that any one part of the sail ought to have, is left undetermined also; so that we are still at a loss for the proper *data* to apply the theorem. However, being willing to avail myself thereof, and considering that any angle from 15° to 18° was best suited to a plane, and of consequence the best

* Maclaurin's account of Sir Isaac Newton's philosophical discoveries, p. 176, art. 29.

mean angle, I made the fail, at the middle distance between the center and the extremity, to stand at an angle of $15^{\circ} 41$ with the plane of the motion; in which case the velocity of that part of the fail, when loaded to a *maximum*, would be equal to that of the wind, or $c = a$. This being determined, the rest were inclined according to the theorem, as follows :

		Angle with the axis.	Angle of weather.	
Parts of the radius from the center.	$\left\{ \begin{array}{l} \frac{1}{6} \text{ -- } c = \frac{1}{3} a \\ \frac{2}{6} \text{ -- } c = \frac{2}{3} a \\ \frac{1}{2} \text{ -- } c = a \\ \frac{2}{3} \text{ -- } c = 1\frac{1}{3} a \\ \frac{5}{6} \text{ -- } c = 1\frac{3}{2} a \\ 1 \text{ -- } c = 2a \end{array} \right.$	$63^{\circ} 26'$	$26^{\circ} 34'$	
		$69 54$	$20 6$	
		$74 19$	$15 41$	middle
		$77 20$	$12 40$	
		$79 27$	$10 33$	
		$81 0$	$9 0$	extremity.

The result hereof was according to N^o. 5. being nearly the same as the plane fails, in their best position: but being turned round in their sockets, so that every part of each fail stood at an angle of 3° , and afterwards of 6° , greater than before, that is, their extremities being moved from 9° to 12° and 15° , the products were advanced to 518 and 527 respectively. Now from the small difference between those two products, we may conclude, that they were nearly in their best position, according to N^o. 7. or some angle between that and N^o. 6: but from these, as well as the plane fails and others, we may also conclude, that *a variation in the angle of a degree or two makes very little difference in the effect, when the angle is near upon the best.*

It is to be observed, that a fail inclined by the preceding rule will expose a convex surface to the wind: whereas the Dutch, and all our modern

mill-builders, tho' they make the angle to diminish, in receding from the center towards the extremity, yet constantly do it in such manner, as that the surface of the sail may be concave towards the wind. In this manner the sails made use of in N^o. 8, 9, 10, 11, 12, and 13. were constructed; the middle of the sail making an angle with the extreme bar of 12°; and the greatest angle (which was about $\frac{1}{3}$ of the radius from the centre) of 15° therewith. Those sails being tried in various positions, the best appears to be that of N^o. 11. where the extremities stood at an angle of $7^{\circ}\frac{1}{2}$ with the plane of motion, the product being 639: greater than that of those made by the theorem in the ratio of 9: 11, and double to that of N^o. 1.; and this was the greatest product that could be procured without an augmentation of surface. Hence it appears, that *when the wind falls upon a concave surface, it is an advantage to the power of the whole, tho' every part, taken separately, should not be disposed to the best advantage* *.

Having thus obtained the best position of the sails, or manner of weathering, as it is called by workmen, the next point was to try what advantage could be

* By several trials in large I have found the following angles to answer as well as any. The radius is supposed to be divided into 6 parts and 1-6th, reckoning from the center, is called 1, the extremity being denoted 6.

N ^o .	Angle with the axis.	Angle with the plane of motion.
1	72°	18°
2	71	19
3	72	18 middle.
4	74	16
5	$77^{\circ}\frac{1}{2}$	$12^{\circ}\frac{1}{2}$
6	83	7 extremity.

made

made by an addition of surface upon the same radius. For this purpose, the sails made use of had the same weather as those N^o. 8. to 13, with an addition to the leading side of each of a triangular cloth, whose height was equal to the height of the sail, and whose base was equal to half the breadth: of consequence the increase of surface upon the whole was one fourth part, or as 4 : 5. Those sails, by being turned round in their sockets, were tried in four different positions, specified in N^o. 14, 15, 16, and 17; from whence it appears, that the best was when every part of the sail made a greater angle by $2^{\circ} \frac{1}{4}$, with the plane of the motion, than those without the addition, as appears by N^o. 15. the product being 820 : this exceeds 639 more than in the ratio of 4 : 5, or that of the increase of cloth. Hence it appears, that *a broader sail requires a greater angle*; and *that when the sail is broader at the extremity, than near the center, this shape is more advantageous than that of a parallelogram* *.

Many have imagined, that the more sail, the greater the advantage, and have therefore proposed to fill up the whole area: and by making each sail a sector of an ellipsis, according to Monsieur Parint, to intercept the whole cylinder of wind, and thereby to produce the greatest effect possible.

* The figure and proportion of the enlarged sails, which I have found best to answer in large, are represented in the figure, Plate VI. where the extreme bar is $\frac{1}{3}$ d of the radius (or whip, as it is called by the workmen), and is divided by the whip in the proportion of 3 to 5. The triangular or leading sail is covered with board from the point downwards $\frac{1}{3}$ d of its height, the rest with cloth as usual. The angles of weather in the preceding note are best for the enlarged sails also; for in practice it is found, that the sails had better have too little than too much weather.

We have therefore proceeded to inquire, how far the effect could be increased by a further enlargement of the surface, upon the same radius of which N^o. 18 and 19 are specimens. The surfaces indeed were not made planes, and set at an angle of 35°, as Parint proposed; because, from N^o. 1. we learn, that this position has nothing to do, when we intend them to work to the greatest advantage. We therefore gave them such an angle as the preceding experiments indicated for such sort of sails, *viz.* 12° at the extremity, and 22° for the greatest weather. By N^o. 18 we have the product 1059, greater than N^o. 15. in the ratio of 7 : 9; but then the augmentation of cloth is almost 7 : 12. By N^o. 19. we have the product 1165, that is greater than N^o. 15. as 7 : 10; but the augmentation of cloth is nearly as 7 : 16; consequently had the same quantity of cloth as in N^o. 18. been disposed in a figure similar to that of N^o. 15, instead of the product 1059, we should have had the product 1386; and in N^o. 19, instead of the product 1165, we should have had a product of 1860; as will be further made appear in the course of the following deductions. Hence it appears, that beyond a certain degree, the more the area is crowded with sail, the less effect is produced in proportion to the surface: and by pursuing the experiments still further, I found, that tho' in N^o. 19. the surface of all the sails together were not more than 7-8ths of the circular area containing them, yet a further addition rather diminished than increased the effect. *So that when the whole cylinder of wind is intercepted, it does not then produce the greatest effect for want of proper interstices to escape.*

It

It is certainly desirable, that the sails of windmills should be as short as possible; but at the same time it is equally desirable, that the quantity of cloth should be the least that may be, to avoid damage by sudden squalls of wind. The best structure, therefore, for large mills, is that where the quantity of cloth is the greatest, in a given circle, that can be: on this condition, that the effect holds out in proportion to the quantity of cloth; for otherwise the effect can be augmented in a given degree by a lesser increase of cloth upon a larger radius, than would be required, if the cloth was increased upon the same radius. The most useful figure therefore for practice, is that of N°. 9. or 10. as has been experienced upon several mills in large.

TABLE IV. *Containing the Result of six Sets of Experiments, made for determining the Difference of Effect, according to the different Velocity of the Wind.*

N. B. The fails were of the same size and kind as those of N° 10, 11, and 12, Tab. IV. Continuance of the Experiment one minute.

N°	Angle at the extremity.	Velocity of the wind in a second.	Turns of the fails unloaded.	Turns of the fails at maximum.	Load at the maximum.	Greatest load.	Product.	Maximum load for the half velocity.	Turns of the fails therewith.	Product of lesser load and greater velocity.	Ratio of the two products.	Ratio of the greatest velocity to the velocity at a maxim ^m .	Ratio of the greatest load to the load at a maximum.
1	5°	4 4½	96	66	lb. 4,47	lb. 5,37	295	—	—	—	—	10:6,9	10:8,3
2	5	8 9	207	122	16,42	18,06	2003	4,47	180	805	10:27,3	10:5,9	10:9,1
3	7½	4 4½	—	65	4,62	—	300	—	—	—	—	—	—
4	7½	8 9	—	130	17,52	—	2278	4,62	180	832	10:27,8	—	—
5	10	4 4½	91	61	5,03	5,87	307	—	—	—	—	10:6,7	10:8,5
6	10	8 9	178	110	18,61	21,34	2047	5,03	158	795	10:26,	10:6,2	10:8,7
1	2	3	4	5	6	7	8	9	10	11	12	13	14

II. *Concerning the ratio between the velocity of windmill sails unloaded, and their velocity when loaded to a maximum.*

Those ratio's, as they turned out in experiments upon different kinds of sails, and with different inclinations (the velocity of the wind being the same) are contained in column 10 of tab. III. where the extremes differ from the ratio of 10 : 7,7 to that of 10 : 5,8; but *the most general ratio of the whole will be nearly as 3 : 2.* This ratio also agrees sufficiently near with experiments where the velocity of the wind was different, as in those contained in tab. IV. col. 13. in which the ratio's differ from 10 : 6,9 to that of 10 : 5,9. However, it appears in general, that where the power is greater, whether by an enlargement of surface, or a greater velocity of the wind, that the second term of the ratio is less.

III. *Concerning the ratio between the greatest load that the sails will bear without stopping, or what is nearly the same thing, between the least load that will stop the sails, and the load at the maximum.*

Those ratio's for different kinds of sails and inclinations, are collected in col. 11. tab. III. where the extremes differ from the ratio of 10 : 6 to that of 10 : 9,2; but taking in those sets of experiments only, where the sails respectively answered best, *the ratio's will be confined between that of 10 : 8 and of 10 : 9; and at a medium about 10 : 8,3 or of 6 : 5.* This ratio also agrees nearly with those in col. 14 of tab. IV. However it appears, upon the whole, that in those instances, where the angle of the sails or

quantity of cloth were greatest, that the second term of the ratio was less.

IV. *Concerning the effects of sails, according to the different velocity of the wind.*

Maxim 1. *The velocity of windmill sails, whether unloaded, or loaded so as to produce a maximum, is nearly as the velocity of the wind, their shape and position being the same.*

This appears by comparing together the respective numbers of columns 4 and 5, tab. IV. wherein those of numbers 2, 4, and 6, ought to be double of numbers 1, 3, and 5: but as the deviation is no-where greater than what may be imputed to the inaccuracy of the experiments themselves, and hold good exactly in numbers 3 and 4; which setts were deduced from the medium of a number of experiments, carefully repeated the same day, and on that account are most to be depended upon; we may therefore conclude the maxim true.

Maxim 2. *The load at the maximum is nearly, but somewhat less than, as the square of the velocity of the wind, the shape and position of the sails being the same.*

This appears by comparing together the numbers in col. 6. tab. IV. wherein those of numbers 2, 4, and 6 (as the velocity is double), ought to be quadruple of those of numbers 1, 3, and 5; instead of which they fall short, number 2 by $\frac{1}{17}$, number 4 by $\frac{1}{19}$, and number 6 by $\frac{1}{13}$ part of the whole. The greatest of those deviations is not more considerable than might be imputed to the unavoidable errors

errors in making the experiments: but as those experiments, as well as those of the greatest load, all deviate the same way; and also coincide with some experiments communicated to me by Mr. Roufe upon the resistance of planes; I am led to suppose a small deviation, whereby the load falls short of the squares of the velocity; and since the experiments N^o 3 and 4. are most to be depended upon, we must conclude, that when the velocity is double, the load falls short of its due proportion by $\frac{1}{10}$, or, for the sake of a round number, by about $\frac{1}{10}$ part of the whole.

Maxim 3d. *The effects of the same sails at a maximum are nearly, but somewhat less than, as the cubes of the velocity of the wind.*

It has already been proved, Maxim 1st, that the velocity of sails at the *maximum*, is nearly as the velocity of the wind; and by Maxim 2d, that the load at the *maximum* is nearly as the square of the same velocity: if those two maximums would hold precisely, it would be a consequence that the effect would be in a triplicate ratio thereof: how this agrees with experiment will appear by comparing together the products in col. 8. of tab. 4. wherein those of N^o 2. 4. and 6. (the velocity of the wind being double) ought to be octuple of those of N^o 1. 3. and 5. instead of which they fall short, N^o 2. by $\frac{1}{7}$ N^o 4. by $\frac{1}{10}$, and N^o 6. by $\frac{1}{6}$ part of the whole. Now, if we rely on N^o 3. and 4. as the turns of the sails are as the velocity of the wind; and since the load of the maximum falls short of the square of the velocity by about $\frac{1}{10}$ part of the whole: the product

X 2 made

made by the multiplication of the turns into the load, must also fall short of the triplicate ratio by about $\frac{1}{20}$ part of the whole product.

Maxim 4th. *The load of the same sails at the maximum is nearly as the squares, and their effect as the cubes, of their number of turns in a given time.*

This maxim may be esteemed a consequence of the three preceding ; for if the turns of the sails are as the velocity of the wind, whatever quantities are in any given ratio of the velocity of the wind, will be in the same given ratio of the turns of the sails : and therefore, if the load at the *maximum* is as the square, or the effect as the cube, of the velocity of the wind, wanting $\frac{1}{20}$ part when the velocity is double ; the load at the *maximum* will also be as the square, and the effect as the cube, of the number of turns of the sails in a given time, wanting in like manner $\frac{1}{20}$ part when the number of turns are double in the same time. In the present case, if we compare the loads at the *maximum* col. 6. with the squares of the number of turns col. 5. of N^o 1 and 2. 5 and 6. or the products of the same numbers col. 8. with the cubes of the number of turns col. 5. instead of falling short, as N^o 3 and 4. they exceed those ratios : but as the sets of experiments N^o 1 and 2. 5 and 6. are not to be esteemed of equal authority with those of N^o 3 and 4. we must not rely upon them further than to observe, that *in comparing the gross effects of large machines, the direct proportion of the squares and cubes respectively, will hold as near as the effects themselves can be observed ;* and therefore

fore be sufficient for practical estimation, without any allowance.

Maxim 5th. When sails are loaded so as to produce a maximum at a given velocity, and the velocity of the wind increases, the load continuing the same; 1stly, The increase of effect, when the increase of the velocity of the wind is small, will be nearly as the squares of those velocities: 2dly, When the velocity of the wind is double, the effects will be nearly as $10:27\frac{1}{2}$: But, 3dly, When the velocities compared, are more than double of that where the given load produces a maximum, the effects increase nearly in a simple ratio of the velocity of the wind.

It has already been proved, maxim 1st and 2d, that when the velocity of the wind is increased, the turns of the sails will increase in the same proportion, even when opposed by a load as the square of the velocity; and therefore if wanting the opposition of an increase of load, as the square of the velocity, the turns of the sails will again be increased in a simple ratio of the velocity of the wind on that account also; that is, the load continuing the same, the turns of the sails in a given time will be as the square of the velocity of the wind; and the effect, being in this case as the turns of the sails, will be as the square of the velocity of the wind also; but this must be understood only of the first increments of the velocity of the wind: for,

2dly, As the sails will never acquire above a given velocity in relation to the wind, tho' the load was diminished to nothing; when the load continues the
same,

same, the more the velocity of the wind increases (tho' the effect will continue to increase) yet the more it will fall short of the square of the velocity of the wind; so that when the velocity of the wind is double, the increase of effect, instead of being as 1 : 4, according to the squares, it turns out as 10 : $27\frac{1}{2}$, as thus appears. In tab. 4. col. 9. the loads of N^o 2, 4, and 6. are the same as the maximum loads in col. 6. of N^o 1, 3, and 5. The number of turns of the sails with those loads, when the velocity of the wind is double, are set down in col. 10. and the products of their multiplication in col. 11 : those being compared with the products of N^o 1, 3, and 5. col. 8. furnish the ratios set down in col. 12. which at a medium (due regard being had to N^o 3 and 4.) will be nearly as 10 : $27\frac{1}{2}$. 3dly. The load continuing the same, grows more and more inconsiderable, respecting the power of the wind as it increases in velocity; so that the turns of the sails grow nearer and nearer a coincidence with their turns unloaded; that is, nearer and nearer to the simple ratio of the velocity of the wind. When the velocity of the wind is double, the turns of the sails, when loaded to a maximum, will be double also; but, *unloaded*, will be no more than triple, by deduction 2d: and therefore the product could not have increased beyond the ratio of 10 : 30 (instead of 10 : $27\frac{1}{2}$) even supposing the sails not to have been retarded at all by carrying the maximum load for the half velocity. Hence we see, that when the velocity of the wind exceeds the double of that, where a constant load produces a maximum, that the increase of effect, which follows the increase of the velocity of the sails, will be nearly as the velocity

city of the wind, and ultimately in that ratio precisely. Hence also we see that windmills, such as the different species for raising water for drainage, &c. lose much of their full effect, when acting against one invariable opposition.

V. *Concerning the effects of sails of different magnitudes, the structure and position being similar, and the velocity of the wind the same.*

Maxim 6. *In sails of a similar figure and position, the number of turns in a given time will be reciprocally as the radius or length of the sail.*

The extreme bar having the same inclination to the plain of its motion, and to the wind; its velocity at a *maximum* will always be in a given ratio to the velocity of the wind; and therefore, whatever be the radius, the absolute velocity of the extremity of the sail will be the same: and this will hold good respecting any other bar, whose inclination is the same, at a proportionable distance from the center; it therefore follows, that the extremity of all similar sails, with the same wind, will have the same absolute velocity; and therefore take a space of time to perform one revolution in proportion to the radius; or, which is the same thing, the number of revolutions in the same given time, will be reciprocally as the length of the sail.

Maxim 7. *The load at a maximum that sails of a similar figure and position will overcome, at a given distance from the center of motion, will be as the cube of the radius.*

Geometry informs us, that in similar figures the surfaces are as the squares of their similar sides; of consequence the quantity of cloth will be as the square of the radius: also in similar figures and positions, the impulse of the wind, upon every similar section of the cloth, will be in proportion to the surface of that section; and consequently, the impulse of the wind upon the whole, will be as the surface of the whole: but as the distance of every similar section, from the center of motion, will be as the radius; the distance of the center of power of the whole, from the center of motion, will be as the radius also; that is, the lever by which the power acts, will be as the radius: as therefore the impulse of the wind, respecting the quantity of cloth, is as the square of the radius, and the lever, by which it acts, as the radius simply; it follows, that the load which the sails will overcome, at a given distance from the center, will be as the cube of the radius.

Maxim 8. The effect of sails of similar figure and position, are as the square of the radius.

By maxim 6. it is proved, that the number of revolutions made in a given time, are as the radius inversely. Under maxim 7. it appears, that the length of the lever, by which the power acts, is as the radius directly; therefore these equal and opposite ratios destroy one another: but as in similar figures the quantity of cloth is as the square of the radius, and the action of the wind is in proportion to the quantity of cloth, as also appears under maxim 7; it follows that the effect is as the square of the radius.

COROL.

COROL. 1. Hence it follows, that augmenting the length of the fail, without augmenting the quantity of cloth, does not increase the power; because what is gained by the length of the lever, is lost by the slowness of the rotation.

COROL. 2. If fails are increased in length, the breadth remaining the same, the effect will be as the radius.

VI. *Concerning the velocity of the extremities of windmill sails, in respect to the velocity of the wind.*

Maxim 9. *The velocity of the extremities of Dutch sails, as well as of the enlarged sails, in all their usual positions when unloaded, or even loaded to a maximum, are considerably quicker than the velocity of the wind.*

The *Dutch* fails unloaded, as in Tab. 3. No 8. made 120 revolutions in 52": the diameter of the fails being 3 feet 6 inches, the velocity of their extremities will be 25,4 feet in a second; but the velocity of the wind producing it, being 6 feet in the same time, we shall have $6 : 25,4 :: 1 : 4,2$; in this case therefore, the velocity of their extremities was 4,2 times greater than that of the wind. In like manner, the relative velocity of the wind, to the extremities of the same fails, when loaded to a *maximum*, making then 93 turns in 52", will be found to be as $1 : 3,3$; or 3,3 times quicker than that of the wind.

The following table contains 6 examples of *Dutch* fails, and 4 examples of the enlarged fails, in different positions, but with the constant velocity of the wind of 6 feet in a second, from table 3: and also 6 examples of *Dutch* fails in different positions, with different velocities of the wind, from table 4.

TABLE V. containing the ratio of the velocity of the extremities of windmill fails to the velocity of the wind.

N ^o	N ^o of Tab. III and IV.	Angle at the Extremity.	Velocity of the wind in a second.	Ratio of the velocity of the wind and extremities of the fails.		
				unloaded.	loaded.	
1	8	0°	6 ^f 0 ⁱⁿ	1:4,2	1:3,3	From Table III.
2	9	3	6 0	1:4,2	1:2,8	
3	10	5	6 0	— — —	1:2,75	
4	11	7½	6 0	1:4,	1:2,7	
5	12	10	6 0	1:3,8	1:2,6	
6	13	12	6 0	1:3,5	1:2,3	
7	14	7½	6 0	1:4,3	1:2,6	From Table III.
8	15	10	6 0	1:4,1	1:2,6	
9	16	12	6 0	1:4,	1:2,3	
10	17	15	6 0	1:3,35	1:2,2	
11	1	5	4 4½	1:4,	1 2,8	From Tab. IV.
12	2	5	8 9	1:4,3	1 2,6	
13	3	7½	4 4½	— — —	1:2,8	
14	4	7½	8 9	— — —	1:2,7	
15	5	10	4 4½	1:3,8	1 2,6	
16	6	10	8 9	1:3,4	1:2 3	
1	2	3	4	5	6	

It appears from the preceding collection of examples, that when the extremities of the *Dutch* fails are parallel to the plane of motion, or at right angles to the wind, and to the axis, as they are made according to the common practice in *England*, that their velocity, unloaded, is above 4 times, and loaded to a *maximum*, above 3 times greater than that of the wind: but that when the *Dutch* fails, or enlarged fails, are in their best positions, their velocity unloaded is 4 times, and loaded to a *maximum*, at a medium the *Dutch* fails are 2,7, and the enlarged fails 2,6 times greater than the velocity of the wind. Hence we are furnished with a method of knowing the velocity of the wind, from observing the velocity of the windmill fails; for knowing the radius, and the number of turns in a minute, we shall have the velocity of the extremities; which, divided by the following divisors, will give the velocity of the wind.

Dutch fails in their common position	{	unloaded 4.2
		loaded —3.3
Dutch fails in their best position --	{	unloaded 4.0
		loaded —2.7
Enlarged fails in their best position	{	unloaded 4.0
		loaded— 2.6

From the above divisors there arises the following compendiums; supposing the radius to be 30 feet, which is the most usual length in this country, and the mill to be loaded to a *maximum*, as is usually the case with corn mills; for every 3 turns in a minute, of the *Dutch* fails in their common position, the wind will move at the rate of 2 miles an hour; for every 5 turns in a minute, of the *Dutch* fails in their best

position, the wind moves 4 miles an hour; and for every 6 turns in a minute, of the enlarged sails in their best position, the wind will move 5 miles an hour.

The following table, which was communicated to me by my friend Mr. Rouse, and which appears to have been constructed with great care, from a considerable number of facts and experiments, and which having relation to the subject of this article; I here insert it as he sent it to me: but at the same time must observe, that the evidence for those numbers where the velocity of the wind exceeds 50 miles an hour, do not seem of equal authority with those of 50 miles an hour and under. It is also to be observed, that the numbers in col. 3. are calculated according to the square of the velocity of the wind, which, in moderate velocities, from what has been before observed, will hold very nearly.

TABLE

TABLE VI. containing the velocity and force of wind, according to their common appellations.

Velocity of the Wind.		Perpendicular force on one foot area in pounds averdupois.	Common appellations of the force of winds.
Miles in one Hour.	Feet in one second.		
1	1,47	,005	Hardly perceptible.
2	2,93	,020	
3	4,40	,044	Just perceptible.
4	5,87	,079	
5	7,33	,123	Gentle pleafant wind.
10	14,07	,492	
15	22,00	1,107	Pleasant brisk gale.
20	29,34	1,968	
25	36,67	3,075	Very brisk.
30	44,01	4,429	
35	51,34	6,027	High winds.
40	58,68	7,873	
45	66,01	9,903	Very high.
50	73,35	12,300	
60	88,02	17,715	A storm or tempest.
80	117,36	31,490	A great storm.
100	146,70	49,200	An hurricane.
			An hurricane that tears up trees, carries buildings before it, &c.
1	2.	3	

VII. concerning the absolute effect, produced by a given velocity of the wind, upon sails of a given magnitude and construction.

It has been observed by practitioners, that in mills with Dutch fails in the common position, that when they make about 13 turns in a minute, they then work

work at a mean rate: that is, by the compendiums in the last article, when the velocity of the wind is $8\frac{2}{3}$ miles an hour, or $12\frac{2}{3}$ feet in a second; which, in common phrase, would be called a *fresh gale*.

The experiments set down in Tab. IV. N^o 4. were tried with a wind, whose velocity was $8\frac{2}{3}$ feet in a second; consequently had those experiments been tried with a wind, whose velocity was $12\frac{2}{3}$ feet in a second, the effect, by maxim 3d, would have been 3 times greater; because the cube of $12\frac{2}{3}$ is 3 times greater than that of $8\frac{2}{3}$.

From Tab. IV. N^o 4. we find, that the sails, when the velocity of the wind was $8\frac{2}{3}$ feet in a second, made 130 revolutions in a minute, with a load of 17,25 lb. From the measures of the machine, preceding the specimen of a set of experiments, we find, that 20 revolutions of the sails raised the scale and weight 11,3 inches: 130 revolutions will therefore raise the scale 73,45 inches, which, multiplied by 17,52 lb, makes a product of 1287, for the effect of the Dutch sails in their best position; that is, when the velocity of the wind is $8\frac{2}{3}$ feet in a second: this product therefore multiplied by three, will give 3861 for the effect of the same sails, when the velocity of the wind is $12\frac{2}{3}$ feet in a second.

Desaguliers makes the utmost power of a man, when working so as to be able to hold it for some hours, to be equal to that of raising an hoghead of water 10 feet high in a minute. Now, an hoghead consisting of 63 ale gallons, being reduced into pounds averdupois, and the height into inches; the product made by multiplying those two numbers will be 76800; which is 19 times greater than the
pro-

product of the fails last-mentioned, at $12\frac{1}{2}$ feet in a second: therefore, by maxim 8th, if we multiply the square root of 19, that is 4,46, by 21 inches, the length of the fail producing the effect 3861, we shall have 93,66 inches, or 7 feet $9\frac{2}{3}$ inches for the radius of a Dutch fail in its best position, whose mean power shall be equal to that of a man: but if they are in their common position, their length must be increased in the ratio of the square root of 442 to that of 639, as thus appears;

The ratio of the *maximum* products of N^o 8 and 11. Tab. III. are as 442:639; but by maxim 8, the effects of fails of different radii are as the square of the radii; consequently the the square roots of the products or effects, are as the radii simply; and therefore as the square root of 442 is to that of 639; so is 93,66 to 112,66; or 9 feet $4\frac{2}{3}$ inches.

If the fails are of the enlarged kind, then from Tab. III. N^o 11 and 15. we shall have the square root of 820 to that of 639::93,66:82,8 inches, or 6 feet $10\frac{3}{4}$ inches: so that in round numbers we shall have the radius of a fail, of a similar figure to their respective models, whose mean power shall be equal to that of a man;

The Dutch fails in their common position $9\frac{1}{2}$ feet.
 The Dutch fails in their best position — 8
 The enlarged fails in their best position — 7

Suppose now the radius of a fail to be 30 feet, and to be constructed upon the model of the enlarged fails, N^o 14 or 15. Tab. III. dividing 30 by 7 we, shall have 4,28, the square of which is 18,3; and this, according to maxim 7, will be the relative

power of a sail of 30 feet, to one of 7 feet; that is, when working at a mean rate, the 30 feet sail will be equal to the power of 18,3 men, or of $3\frac{2}{3}$ horses; reckoning 5 men to a horse: whereas the effect of the common Dutch sails, of the same length, being less in the proportion of 820:442, will be scarce equal to the power of 10 men, or of 2 horses.

That these computations are not merely speculative, but will nearly hold good when applied to works in large, I have had an opportunity of verifying: for in a mill with the enlarged sails of 30 feet, applied to the crushing of rape seed, by means of two runners upon the edge, for making oil; I observed, that when the sails made 11 turns in a minute, in which case the velocity of the wind was about 13 feet in a second, according to article 6th, that the runners then made 7 turns in a minute: whereas 2 horses, applied to the same 2 runners, scarcely worked them at the rate of $3\frac{1}{2}$ turns in the same time. Lastly, with regard to the real superiority of the enlarged sails, above the Dutch sails as commonly made, it has sufficiently appeared, not only in those cases where they have been applied to new mills, but where they have been substituted in the place of the others.

VIII. *Concerning horizontal windmills and water-wheels, with oblique vanes.*

Observations upon the effects of common windmills with oblique vanes, have led many to imagine, that could the vanes be brought to receive the direct impulse, like a ship sailing before the wind, it would
be

be a very great improvement in point of power : while others attending to the extraordinary and even unexpected effects of oblique vanes, have been led to imagine, that oblique vanes applied to water-mills, would as much exceed the common water wheels, as the vertical windmills are found to have exceeded all attempts towards an horizontal one. Both these notions, but especially the first, have so plausible an appearance, that of late years there has seldom been wanting those, who have affiduously employed themselves to bring to bear designs of this kind : it may not therefore be unacceptable to endeavour to set this matter in a clear light.

PLATE VI. fig 2d. Let AB be the section of a plain, upon which let the wind blow in the direction CD , with such a velocity as to describe a given space BE , in a given time (suppose 1 second); and let AB be moved parallel to itself, in the direction CD . Now, if the plane AB moves with the same velocity as the wind; that is, if the point B moves thro' the space BE in the same time that a particle of air would move thro' the same space; it is plain that, in this case, there can be no pressure or impulse of the wind upon the plane : but if the plane moves slower than the wind, in the same direction, so that the point B may move to F , while a particle of air, setting out from B at the same instant, would move to E , then BF will express the velocity of the plane; and the relative velocity of the wind and plane will be expressed by the line FE . Let the ratio of FE to BE be given (suppose $2 : 3$.); let the line AB represent the impulse of the wind upon the plane AB , when acting with its whole velocity BE ; but,

when acting with its relative velocity FE , let its impulse be denoted by some aliquot part of AB , as for instance $\frac{4}{9} AB$: then will $\frac{4}{9}$ of the parallelogram AF represent the mechanical power of the plane; that is, $\frac{4}{9} AB \times \frac{1}{3} BE$.

2dly, Let IN be the section of a plane, inclined in such a manner, that the base IK of the rectangle triangle IKN may be equal to AB ; and the perpendicular $NK=BE$; let the plane IN be struck by the wind, in the direction LM , perpendicular to IK : then, according to the known rules of oblique forces, the impulse of the wind upon the plain IN , tending to move it according to the direction LM , or NK , will be denoted by the base IK ; and that part of the impulse, tending to move it according to the direction IK , will be expressed by the perpendicular NK . Let the plane IN be moveable in the direction of IK only; that is, the point I in the direction of IK , and the point N in the direction NQ , parallel thereto. Now it is evident, that if the point I moves thro' the line IK , while a particle of air, setting forwards at the same time from the point N , moves thro' the line NK , they will both arrive at the point K at the same time; and consequently, in this case also, there can be no pressure or impulse of the particle of the air upon the plane IN . Now let IO be to IK as BF to BE ; and let the plane IN move at such a rate, that the point I may arrive at O , and acquire the position OQ , in the same time that a particle of wind would move thro' the space NK : as OQ is parallel to IN ; (by the properties of similar triangles) it will cut NK in the point P , in such a manner, that $NP=BF$, and $PK=FE$: hence it appears,

appears, that the plane IN , by acquiring the position OQ , withdraws itself from the action of the wind, by the same space NP , that the plane AB does by acquiring the position FG ; and consequently, from the equality of PK to FE , the relative impulse of the wind PK , upon the plane OQ , will be equal to the relative impulse of the wind FE , upon the plane FG : and since the impulse of the wind upon AB , with the relative velocity FE , in the direction BE , is represented by $\frac{4}{9} AB$; the relative impulse of the wind upon the plane IN , in the direction NK , will in like manner be represented by $\frac{4}{9} IK$; and the impulse of the wind upon the plane IN , with the relative velocity PK , in the direction IK , will be represented by $\frac{4}{9} NK$: and consequently the mechanical power of the plane IN , in the direction IK , will be $\frac{4}{9}$ the parallelogram IQ : that is $\frac{1}{3} IK \times \frac{4}{9} NK$: that is, from the equality of $IK=AB$ and $NK=BE$, we shall have $\frac{4}{9} IQ = \frac{1}{3} AB \times \frac{4}{9} BE = \frac{4}{9} AB \times \frac{1}{3} BE = \frac{4}{9}$ of the area of the parallelogram AF . Hence we deduce this

GENERAL PROPOSITION,

That all planes, however situated, that intercept the same section of the wind, and having the same relative velocity, in regard to the wind, when reduced into the same direction, have equal powers to produce mechanical effects.

For what is lost by the obliquity of the impulse, is gained by the velocity of the motion.

Hence it appears, that an oblique sail is under no disadvantage in respect of power, compared with a direct one; except what arises from a diminution of

its breadth, in respect to the section of the wind: the breadth IN being by obliquity reduced to IK .

The disadvantage of horizontal windmills therefore does not consist in this; that each sail, when directly exposed to the wind, is capable of a less power, than an oblique one of the same dimensions; but that in an horizontal windmill, little more than one sail can be acting at once: whereas in the common windmill, all the four act together: and therefore, supposing each vane of an horizontal windmill, of the same dimensions as each vane of the vertical, it is manifest the power of a vertical mill with four sails, will be four times greater than the power of the horizontal one, let its number of vanes be what it will: this disadvantage arises from the nature of the thing; but if we consider the further disadvantage, that arises from the difficulty of getting the sails back again against the wind, &c. we need not wonder if this kind of mill is in reality found to have not above $\frac{1}{8}$ or $\frac{1}{10}$ of the power of the common sort; as has appeared in some attempts of this kind.

In like manner, as little improvement is to be expected from water-mills with oblique vanes: for the power of the same section of a stream of water, is not greater when acting upon an oblique vane, than when acting upon a direct one: and any advantage that can be made by intercepting a greater section, which sometimes may be done in the case of an open river, will be counterbalanced by the superior resistance, that such vanes would meet with by moving at right angles to the current: whereas the common floats always move with the water nearly in the same direction.

Here

Here it may reasonably be asked, that since our geometrical demonstration is general, and proves, that one angle of obliquity is as good as another; why in our experiments it appears, that there is a certain angle which is to be preferred to all the rest? It is to be observed, that if the breadth of the sail IN is given, the greater the angle KIN , and the less will be the base IK : that is, the section of wind intercepted, will be less: on the other hand, the more acute the angle KIN , the less will be the perpendicular KN : that is, the impulse of the wind, in the direction IK being less, and the velocity of the sail greater; the resistance of the medium will be greater also. Hence therefore, as there is a diminution of the section of the wind intercepted on one hand, and an increase of resistance on the other, there is some angle, where the disadvantage arising from these causes upon the whole is the least of all; but as the disadvantage arising from resistance is more of a physical than geometrical consideration, the true angle will best be assigned by experiment.

SCHOLIUM.

In trying the experiments contained in Tab. III. and IV. the different specific gravity of the air, which is undoubtedly different at different times, will cause a difference in the load, proportional to the difference of its specific gravity, tho' its velocity remains the same; and a variation of specific gravity may arise not only from a variation of the weight of the whole column, but also by the difference of heat of the air concerned in the experiment, and possibly of other causes; yet the irregularities that might arise from a dif-

difference of specific gravity were thought to be too small to be perceivable, till after the principal experiments were made, and their effects compared; from which, as well as succeeding experiments, those variations were found to be capable of producing a sensible, tho' no very considerable effect: however, as all the experiments were tried in the summer season, in the day-time, and under cover; we may suppose that the principal source of error would arise from the different weight of the column of the atmosphere at different times; but as this seldom varies above $\frac{1}{7}$ part of the whole, we may conclude, that tho' many of the irregularities contained in the experiments referred to in the foregoing essay, might arise from this cause; yet as all the principal conclusions are drawn from the medium of a considerable number, many whereof were made at different times, it is presumed that they will nearly agree with the truth, and be altogether sufficient for regulating the practical construction of those kind of machines, for which use they were principally intended.